

**NFPA<sup>®</sup>**

# 1851

---

**Standard on  
Selection, Care, and  
Maintenance of Protective  
Ensembles for Structural  
Fire Fighting and Proximity  
Fire Fighting**

---

**2020**



## IMPORTANT NOTICES AND DISCLAIMERS CONCERNING NFPA® STANDARDS





NFPA® codes, standards, recommended practices, and guides (“NFPA Standards”), of which the document contained herein is one, are developed through a consensus standards development process approved by the American National Standards Institute. This process brings together volunteers representing varied viewpoints and interests to achieve consensus on fire and other safety issues. While the NFPA administers the process and establishes rules to promote fairness in the development of consensus, it does not independently test, evaluate, or verify the accuracy of any information or the soundness of any judgments contained in NFPA Standards.

The NFPA disclaims liability for any personal injury, property, or other damages of any nature whatsoever, whether special, indirect, consequential or compensatory, directly or indirectly resulting from the publication, use of, or reliance on NFPA Standards. The NFPA also makes no guaranty or warranty as to the accuracy or completeness of any information published herein.

In issuing and making NFPA Standards available, the NFPA is not undertaking to render professional or other services for or on behalf of any person or entity. Nor is the NFPA undertaking to perform any duty owed by any person or entity to someone else. Anyone using this document should rely on his or her own independent judgment or, as appropriate, seek the advice of a competent professional in determining the exercise of reasonable care in any given circumstances.

The NFPA has no power, nor does it undertake, to police or enforce compliance with the contents of NFPA Standards. Nor does the NFPA list, certify, test, or inspect products, designs, or installations for compliance with this document. Any certification or other statement of compliance with the requirements of this document shall not be attributable to the NFPA and is solely the responsibility of the certifier or maker of the statement.

### REVISION SYMBOLS IDENTIFYING CHANGES FROM THE PREVIOUS EDITION

Text revisions are shaded. A  before a section number indicates that words within that section were deleted and a  to the left of a table or figure number indicates a revision to an existing table or figure. When a chapter was heavily revised, the entire chapter is marked throughout with the  symbol. Where one or more sections were deleted, a • is placed between the remaining sections. Chapters, annexes, sections, figures, and tables that are new are indicated with an .

Note that these indicators are a guide. Rearrangement of sections may not be captured in the markup, but users can view complete revision details in the First and Second Draft Reports located in the archived revision information section of each code at [www.nfpa.org/docinfo](http://www.nfpa.org/docinfo). Any subsequent changes from the NFPA Technical Meeting, Tentative Interim Amendments, and Errata are also located there.



### ALERT: THIS STANDARD HAS BEEN MODIFIED BY A TIA OR ERRATA

Users of NFPA codes, standards, recommended practices, and guides (“NFPA Standards”) should be aware that NFPA Standards may be amended from time to time through the issuance of a Tentative Interim Amendment (TIA) or corrected by Errata. An official NFPA Standard at any point in time consists of the current edition of the document together with any TIAs and Errata then in effect.

To determine whether an NFPA Standard has been amended through the issuance of TIAs or corrected by Errata, go to [www.nfpa.org/docinfo](http://www.nfpa.org/docinfo) to choose from the list of NFPA Standards or use the search feature to select the NFPA Standard number (e.g., NFPA 13). The document information page provides up-to-date document-specific information as well as postings of all existing TIAs and Errata. It also includes the option to register for an “Alert” feature to receive an automatic email notification when new updates and other information are posted regarding the document.

## **ADDITIONAL IMPORTANT NOTICES AND DISCLAIMERS CONCERNING NFPA® STANDARDS**

### **Updating of NFPA Standards**

Users of NFPA codes, standards, recommended practices, and guides (“NFPA Standards”) should be aware that these documents may be superseded at any time by the issuance of a new edition, may be amended with the issuance of Tentative Interim Amendments (TIAs), or be corrected by Errata. It is intended that through regular revisions and amendments, participants in the NFPA standards development process consider the then-current and available information on incidents, materials, technologies, innovations, and methods as these develop over time and that NFPA Standards reflect this consideration. Therefore, any previous edition of this document no longer represents the current NFPA Standard on the subject matter addressed. NFPA encourages the use of the most current edition of any NFPA Standard [as it may be amended by TIA(s) or Errata] to take advantage of current experience and understanding. An official NFPA Standard at any point in time consists of the current edition of the document, including any issued TIAs and Errata then in effect.

To determine whether an NFPA Standard has been amended through the issuance of TIAs or corrected by Errata, visit the “Codes & Standards” section at [www.nfpa.org](http://www.nfpa.org).

### **Interpretations of NFPA Standards**

A statement, written or oral, that is not processed in accordance with Section 6 of the Regulations Governing the Development of NFPA Standards shall not be considered the official position of NFPA or any of its Committees and shall not be considered to be, nor be relied upon as, a Formal Interpretation.

### **Patents**

The NFPA does not take any position with respect to the validity of any patent rights referenced in, related to, or asserted in connection with an NFPA Standard. The users of NFPA Standards bear the sole responsibility for determining the validity of any such patent rights, as well as the risk of infringement of such rights, and the NFPA disclaims liability for the infringement of any patent resulting from the use of or reliance on NFPA Standards.

NFPA adheres to the policy of the American National Standards Institute (ANSI) regarding the inclusion of patents in American National Standards (“the ANSI Patent Policy”), and hereby gives the following notice pursuant to that policy:

NOTICE: The user’s attention is called to the possibility that compliance with an NFPA Standard may require use of an invention covered by patent rights. NFPA takes no position as to the validity of any such patent rights or as to whether such patent rights constitute or include essential patent claims under the ANSI Patent Policy. If, in connection with the ANSI Patent Policy, a patent holder has filed a statement of willingness to grant licenses under these rights on reasonable and nondiscriminatory terms and conditions to applicants desiring to obtain such a license, copies of such filed statements can be obtained, on request, from NFPA. For further information, contact the NFPA at the address listed below.

### **Law and Regulations**

Users of NFPA Standards should consult applicable federal, state, and local laws and regulations. NFPA does not, by the publication of its codes, standards, recommended practices, and guides, intend to urge action that is not in compliance with applicable laws, and these documents may not be construed as doing so.

### **Copyrights**

NFPA Standards are copyrighted. They are made available for a wide variety of both public and private uses. These include both use, by reference, in laws and regulations, and use in private self-regulation, standardization, and the promotion of safe practices and methods. By making these documents available for use and adoption by public authorities and private users, the NFPA does not waive any rights in copyright to these documents.

Use of NFPA Standards for regulatory purposes should be accomplished through adoption by reference. The term “adoption by reference” means the citing of title, edition, and publishing information only. Any deletions, additions, and changes desired by the adopting authority should be noted separately in the adopting instrument. In order to assist NFPA in following the uses made of its documents, adopting authorities are requested to notify the NFPA (Attention: Secretary, Standards Council) in writing of such use. For technical assistance and questions concerning adoption of NFPA Standards, contact NFPA at the address below.

### **For Further Information**

All questions or other communications relating to NFPA Standards and all requests for information on NFPA procedures governing its codes and standards development process, including information on the procedures for requesting Formal Interpretations, for proposing Tentative Interim Amendments, and for proposing revisions to NFPA standards during regular revision cycles, should be sent to NFPA headquarters, addressed to the attention of the Secretary, Standards Council, NFPA, 1 Batterymarch Park, P.O. Box 9101, Quincy, MA 02269-9101; email: [stds\\_admin@nfpa.org](mailto:stds_admin@nfpa.org).

For more information about NFPA, visit the NFPA website at [www.nfpa.org](http://www.nfpa.org). All NFPA codes and standards can be viewed at no cost at [www.nfpa.org/docinfo](http://www.nfpa.org/docinfo).

Copyright © 2019 National Fire Protection Association®. All Rights Reserved.

## NFPA® 1851

### Standard on

# Selection, Care, and Maintenance of Protective Ensembles for Structural Fire Fighting and Proximity Fire Fighting

## 2020 Edition

This edition of NFPA 1851, *Standard on Selection, Care, and Maintenance of Protective Ensembles for Structural Fire Fighting and Proximity Fire Fighting*, was prepared by the Technical Committee on Structural and Proximity Fire Fighting Protective Clothing and Equipment, released by the Correlating Committee on Fire and Emergency Services Protective Clothing and Equipment, and acted on by NFPA at its June Association Technical Meeting held June 17–20, 2019, in San Antonio, TX. It was issued by the Standards Council on August 5, 2019, with an effective date of August 25, 2019, and supersedes all previous editions.

This document has been amended by one or more Tentative Interim Amendments (TIAs) and/or Errata. See “Codes & Standards” at [www.nfpa.org](http://www.nfpa.org) for more information.

This edition of NFPA 1851 was approved as an American National Standard on August 25, 2019.

### Origin and Development of NFPA 1851

The first edition of NFPA 1851, published in 2001, was titled *Standard on the Selection, Care, and Maintenance of Structural Fire Fighting Protective Ensembles*. The standard was developed to be a companion document for NFPA 1971, then titled *Standard on Protective Ensembles for Structural Fire Fighting*, which has been in effect since 1975 and specifies product design, performance, testing, and certification.

NFPA 1851 is written for the organizations that evaluate the risks their emergency responders face and their particular needs for protective clothing, that develop purchase specifications, and that purchase structural fire-fighting protective ensembles and ensemble elements. It is also written for end users of structural fire-fighting protective ensembles and ensemble elements to be able to inspect, maintain, and care for the protective ensembles and ensemble elements they use during structural fire-fighting operations.

The overall protection and safety of fire-fighting personnel depend not only on adequate protective clothing but equally on the organization’s policies, training, and administration of the correct use of the proper protective ensembles and ensemble elements in fire-fighting situations. To satisfy the portion of the organization’s overall protective clothing and equipment program that addresses structural fire-fighting protective ensembles and ensemble elements, this document provides criteria for the selection, care, and maintenance of protective ensembles and ensemble elements.

In this standard, the requirements for several areas are written to begin with the person who actually uses the protective ensemble or ensemble element being constantly aware of its condition and need for cleaning, repair, or more in-depth inspection. Users can perform the simple actions to improve the condition of the protective ensemble or ensemble element. The more involved actions of advanced inspection, evaluation, cleaning, decontamination, and repair are handled by the organization’s designated staff trained and authorized to perform such duties. In other areas, the requirements are written for the organization to perform the administrative functions of the structural fire-fighting protective ensemble program and to perform periodic actions to evaluate the program to ensure it is achieving its goals and that the quality of the protective ensembles and ensemble elements provides optimum safety to fire fighters.

The 2008 edition of NFPA 1851 was a complete revision of the first edition. Because NFPA 1976, *Standard on Protective Ensemble for Proximity Fire Fighting*, was incorporated into the 2007 edition of NFPA 1971, *Standard on Protective Ensembles for Structural Fire Fighting and Proximity Fire Fighting*, under

the Technical Committee on Structural and Proximity Fire Fighting Protective Clothing and Equipment, this edition of NFPA 1851 was expanded to include both structural fire-fighting ensembles and proximity fire-fighting ensembles.

The 2008 edition followed the new standards format according to the *Manual of Style for NFPA Technical Committee Documents*.

New requirements in Chapter 11 for organizations and ISPs and for verification of the ISPs by independent, third-party certification organizations set the criteria for organizations and ISPs to perform the tasks of inspection, cleaning, and repairing of protective ensembles and ensemble elements. New requirements for testing methods for trained personnel in the organization as well as the ISPs set the criteria to determine functionality and protection afforded by ensembles and ensemble elements.

Chapter 10 was revised, requiring retirement of structural fire-fighting ensembles and ensemble elements and proximity fire-fighting ensembles and ensemble elements not later than 10 years from the date the ensembles or ensemble elements were manufactured. The radiant reflective outer shell of proximity fire-fighting ensembles and ensemble elements were required to be replaced a maximum of 5 years from the date the ensembles or ensemble elements were manufactured. More frequent replacement of fire-fighting ensembles and ensemble elements was required to better ensure that fire fighters had state-of-the-art protection from fire-fighting environments. The significant changes that technology underwent within two editions of this standard (approximately 10 years), in addition to the normal “wear and tear” of fire-fighting and additional emergency incident responses, training, and other factors, dictated that protective ensembles and ensemble elements be replaced. Fire departments that responded to a higher-than average number of emergency incidents or that had frequent or extensive “working fire” operations were encouraged to plan for replacement of ensembles or ensemble elements on a more frequent cycle.

The 2014 edition of NFPA 1851 was another complete revision and featured many editorial changes as well as new definitions for *manufacturer trained organization*, *verified organization*, and *verified independent service provider (ISP)*. A new table was added to Chapter 4 that specified the responsibilities for garment inspection, cleaning, and repair. Inspection for delamination and label integrity and legibility was added to Chapter 6. Changes were made to the cleaning and decontamination procedures in Chapter 7, and requirements in Chapter 8 for the repair of ensembles and ensemble elements were revised. There were also several changes to Chapter 11 that affected verification of organizations and ISPs, and two new tables were added that addressed advanced inspection and advanced cleaning evaluations.

The 2020 edition has seen major changes to the cleaning requirements in Chapter 4 and Chapter 7 and further changes to supporting definitions. In Chapter 4, the table of responsibilities for garment element inspection, cleaning, and repair has been redone to reflect six different groups that could potentially have one of those responsibilities with accompanying clarifications concerning how that responsibility is accomplished. In Chapter 7, each major heading has been rewritten in light of new technologies and information gleaned from research and testing. Two new decision trees have been added for handling, disposition, and cleaning of ensembles and ensemble elements to assist in determining the appropriate cleaning procedure(s). These changes have also led to a definition and associated annex material for the term *preliminary exposure reduction* to replace *on-scene preliminary cleaning*.

For the 2020 edition, the technical committee has strengthened the annex material associated with the Chapter 10 retirement requirements by expanding on existing language and explaining the work that was done that led to the development of retirement criteria in the standard. The technical committee has also added a paragraph concerning carcinogens and performance testing.

## Correlating Committee on Fire and Emergency Services Protective Clothing and Equipment

**William E. Haskell, III**, *Chair*

National Institute for Occupational Safety & Health, MA [E]

- |  |  |
|--|--|
| <b>Jason L. Allen</b> , Intertek Testing Services, NY [RT]   | <b>Benjamin Mauti</b> , Globe Manufacturing/Mine Safety Appliances Company, PA [M]   |
| <b>James B. Area</b> , Chimera Enterprises International, MD [SE]  | <b>Michael F. McKenna</b> , Michael McKenna & Associates, LLC, CA [SE]   |
| <b>Joseph Arrington</b> , San Antonio Fire Department, TX [U]  | <b>Douglas Menard</b> , Boston Fire Department, MA [U]   |
| <b>Roger L. Barker</b> , North Carolina State University, NC [SE]  | <b>John H. Morris</b> , 3M Company, GA [M]   |
| <b>James E. Brinkley</b> , International Association of Fire Fighters, NY [L]<br>Rep. International Association of Fire Fighters | <b>Jack E. Reall</b> , Columbus (OH) Division of Fire, OH [L]<br>Rep. Columbus Firefighters Union                                |
| <b>Steven D. Corrado</b> , UL LLC, NC [RT]   | <b>Jeffrey O. Stull</b> , International Personnel Protection, Inc., TX [M]   |
| <b>Edmund Farley</b> , Pittsburgh Bureau Of Fire, PA [E]   | <b>Robert D. Tutterow, Jr.</b> , Fire Industry Education Resource Organization (FIERO), NC [U]<br>Rep. NFPA Fire Service Section |
| <b>Patricia A. Gleason</b> , ASTM/Safety Equipment Institute (SEI), VA [RT]  | <b>William A. Van Lent</b> , Veridian Ltd., Inc., IA [M]<br>Rep. Fire & Emergency Manufacturers & Services Association           |
| <b>David V. Haston</b> , U.S. Department of Agriculture, ID [E]  | <b>Bruce H. Varner</b> , BHVarner & Associates, AZ [M]<br>Rep. International Fire Service Training Association                   |
| <b>Diane B. Hess</b> , PBI Performance Products, Inc., NC [M]  | <b>Steven H. Weinstein</b> , Honeywell Safety Products, CA [M]   |
| <b>Thomas M. Hosea</b> , U.S. Department of the Navy, FL [RT]  | <b>Richard Weise</b> , Los Angeles County Fire Department/Safer, CA [U]  |
| <b>Beth C. Lancaster</b> , U.S. Department of Defense, VA [E]  | <b>Harry P. Winer</b> , HIP Consulting LLC, MA [SE]  |
| <b>Jeff Legendre</b> , Northborough Fire Department, MA [U]  |  |
| <b>Karen E. Lehtonen</b> , LION Group, Inc., OH [M]  |  |
| <b>David G. Matthews</b> , Fire & Industrial (PPE) Ltd., United Kingdom [SE]<br>Rep. International Standards Organization        |  |

### Alternates

- |  |  |
|--|--|
| <b>Louis Carpentier</b> , Innotech Inc., Canada [M]<br>(Alt. to William A. Van Lent)   | <b>Stephen R. Sanders</b> , ASTM/Safety Equipment Institute (SEI), VA [RT]<br>(Alt. to Patricia A. Gleason)                        |
| <b>Robin B. Childs</b> , U.S. Department of Defense, VA [E]<br>(Alt. to Beth C. Lancaster)   | <b>Russell Shephard</b> , Australasian Fire & Emergency Service Authorities Council, Australia [SE]<br>(Alt. to David G. Matthews) |
| <b>Patricia A. Freeman</b> , Globe Manufacturing Company, LLC/Mine Safety Appliances Company (MSA), NH [M]<br>(Alt. to Benjamin Mauti) | <b>David P. Stoddard</b> , Michael McKenna & Associates, LLC, CA [SE]<br>(Alt. to Michael F. McKenna)                              |
| <b>Kenneth Hayes</b> , Boston Fire Department, MA [U]<br>(Alt. to Douglas Menard)  | <b>Grace G. Stull</b> , International Personnel Protection, Inc., TX [M]<br>(Alt. to Jeffrey O. Stull)                             |
| <b>Pamela A. Kavalesky</b> , Intertek Testing Services, NY [RT]<br>(Alt. to Jason L. Allen)  | <b>Rick L. Swan</b> , IAFF Local 2881/CDF Fire Fighters, VA [L]<br>(Alt. to James E. Brinkley)                                     |
| <b>Judge W. Morgan</b> , 3M Scott Safety, NC [M]<br>(Alt. to John H. Morris)   | <b>Jonathan V. Szalajda</b> , National Institute for Occupational Safety & Health, PA [E]<br>(Alt. to William E. Haskell, III)     |
| <b>Gary L. Neilson</b> , Sparks, NV [U]<br>(Alt. to Robert D. Tutterow, Jr.)   | <b>Donald B. Thompson</b> , North Carolina State University, NC [SE]<br>(Alt. to Roger L. Barker)                                  |
| <b>Amanda H. Newsom</b> , UL LLC, NC [RT]<br>(Alt. to Steven D. Corrado)   | <b>W. Jason Traynor</b> , MSA Safety, PA [M]<br>(Voting Alt.)  |
| <b>Anthony Petrilli</b> , U.S. Department of Agriculture, MT [E]<br>(Alt. to David V. Haston)  | <b>Jian Xiang</b> , The DuPont Company, Inc., VA [M]<br>(Alt. to Diane B. Hess)  |
| <b>Kevin M. Roche</b> , Facets Consulting, AZ [M]<br>(Alt. to Bruce H. Varner)   |  |

### Nonvoting

- |  |  |
|--|--|
| <b>Robert J. Athanas</b> , FDNY/SAFE-IR, Incorporated, NY [U]<br>Rep. TC on Electronic Safety Equipment              | <b>Brian Montgomery</b> , U.S. Department of Justice, DC [E]<br>Rep. Tactical and Technical Operations Respiratory Protection Equipment  |
| <b>Christina M. Baxter</b> , Emergency Response Tips, LLC, VA [U]<br>Rep. TC on Hazardous Materials PC&E             | <b>Daniel N. Rossos</b> , Oregon Department of Public Safety Standards & Training, OR [E]<br>Rep. TC on Respiratory Protection Equipment |
| <b>George Broyles</b> , U.S. Forest Service, ID<br>Rep. TC on Wildland Fire Fighting PC&E                            | <b>Tim W. Tomlinson</b> , Addison Fire Department, TX [C]  |
| <b>Tricia L. Hock</b> , ASTM/Safety Equipment Institute (SEI), VA [RT]<br>Rep. TC on Emergency Medical Services PC&E |  |
| <b>Jeremy Metz</b> , West Metro Fire Rescue, CO [U]<br>Rep. TC on Special Operations PC&E                            |  |

**Chris Farrell**, NFPA Staff Liaison

*This list represents the membership at the time the Committee was balloted on the final text of this edition. Since that time, changes in the membership may have occurred. A key to classifications is found at the back of the document.*

NOTE: Membership on a committee shall not in and of itself constitute an endorsement of the Association or any document developed by the committee on which the member serves.

**Committee Scope:** This committee shall have primary responsibility for documents on the design, performance, testing, and certification of protective clothing and protective equipment manufactured for fire and emergency services organizations and personnel, to protect against exposures encountered during emergency incident operations. This committee shall also have the primary responsibility for documents on the selection, care, and maintenance of such protective clothing and protective equipment by fire and emergency services organizations and personnel.

## Technical Committee on Structural and Proximity Fire Fighting Protective Clothing and Equipment

**Tim W. Tomlinson**, *Chair*  
Addison Fire Department, TX [C]

**Marni L. Schmid**, *Secretary (Alternate)*  
Fortunes Collide Marketing LLC, MI [U]  
Rep. Fire Industry Education Resource Organization  
(Alt. to Robert D. Tutterow, Jr.)

**Jason L. Allen**, Intertek Testing Services, NY [RT]  
**George E. Berger**, U.S. Marine Corps Installations Command, DC [C]

**Steven D. Corrado**, UL LLC, NC [RT]

**Paul F. Curtis**, L.N. Curtis & Sons, CA [IM]

**Anthony Shawn Deaton**, NC State University, NC [SE]

**Tim Durby**, Prescott Fire Department, AZ [U]

**David P. Fanning**, E. D. Bullard Company, KY [M]

**Jonathan Fesik**, Fire Industry Repair Maintenance Inc., Canada [IM]

**William A. Fithian**, ASTM/Safety Equipment Institute (SEI), VA [RT]

**Patricia A. Freeman**, Globe Manufacturing Company, LLC/Mine Safety Appliances Company (MSA), NH [M]

**Tom Hamma**, Heartland Fire & Rescue, CA [U]

**Allen Ira Harkness**, U.S. Department of the Navy, FL [RT]

**William E. Haskell, III**, National Institute for Occupational Safety & Health, MA [E]

Rep. National Institute for Occupational Safety & Health

**Earl Hayden**, El Paso, TX [L]

Rep. International Association of Fire Fighters

**John M. Karban**, FireDex, LLC, OH [M]

**Kim Klaren**, Fairfax County Fire & Rescue Department, VA [U]

**Steve L. Lakey**, Northwest Safety Clean Inc., OR [IM]

Rep. Verified Independent Services Providers Association

**Karen E. Lehtonen**, Lion Group, Inc., OH [M]

**Michael F. McKenna**, Michael McKenna & Associates, LLC, CA [SE]

**Gene Necklaus**, Scottsboro Fire Department, AL [E]

Rep. International Association of Fire Chiefs

**Louis V. Ott**, Gentex Corporation, PA [M]

**Damian L. Owens**, Charlotte Fire Department, NC [U]

**Tom Ragan**, Shelby Specialty Gloves, TN [M]

**Jim Reidy**, San Antonio Fire Department, TX [L]

Rep. Texas State Association of Fire Fighters

**R. Wendell Robison**, Fillmore, UT [C]

Rep. National Volunteer Fire Council

**Jeffrey O. Stull**, International Personnel Protection, Inc., TX [M]

**Robert D. Tutterow, Jr.**, Fire Industry Education Resource Organization (FIERO), NC [U]

Rep. Fire Industry Education Resource Organization

**James A. Walter**, Honeywell First Responder Products, OH [M]

**Richard Weise**, Los Angeles County Fire Department/Safer, CA [U]

Rep. Southern Area Fire Equipment Research

**Harry P. Winer**, HIP Consulting LLC, MA [SE]

**Patrick J. Woods**, Fire Department City of New York, NY [U]

Rep. Fire Department City of New York

### Alternates

**Roger L. Barker**, North Carolina State University, NC [SE]  
(Alt. to Anthony Shawn Deaton)

**Daniel Buford**, Bryan Fire Department, TX [L]  
(Alt. to Jim Reidy)

**Thomas A. Clark**, Minnesota Professional Fire Fighters, MN [L]  
(Alt. to Earl Hayden)

**Nicholas J. Curtis**, Liberty Township, OH [SE]  
(Alt. to Michael F. McKenna)

**Tyler J. Dennison**, L.N. Curtis And Sons, UT [IM]  
(Alt. to Paul F. Curtis)

**William Matthew Ernst**, E.D. Bullard Company, KY [M]  
(Alt. to David P. Fanning)

**Christopher George Eysser**, New York City Fire Department, NY [U]  
(Alt. to Patrick J. Woods)

**Richard O. Granger, Jr.**, Charlotte Fire Department, NC [U]  
(Alt. to Damian L. Owens)

**Alysha L. Gray**, Lion Group, Inc., OH [M]  
(Alt. to Karen E. Lehtonen)

**Robert Green**, USDOD Naval Base Guam, Guam [E]  
(Alt. to Gene Necklaus)

**Benjamin Hanna**, Intertek, NY [RT]  
(Alt. to Jason L. Allen)

**Todd Herring**, Fire-Dex, OH [M]  
(Alt. to John M. Karban)

**Tricia L. Hock**, ASTM/Safety Equipment Institute (SEI), VA [RT]  
(Alt. to William A. Fithian)

**Rickey Johnson, Jr.**, Addison Fire Department, TX [C]  
(Alt. to Tim W. Tomlinson)

**Amanda H. Newsom**, UL LLC, NC [RT]  
(Alt. to Steven D. Corrado)

**Brett O'Mara**, U.S. Marine Corps, AZ [C]  
(Alt. to George E. Berger)

**Andrew R. Oliver**, Gear Wash LLC, WI [IM]  
(Alt. to Jonathan Fesik)

**John F. Rihn**, Globe Manufacturing/Mine Safety Appliances Company, PA [M]  
(Alt. to Patricia A. Freeman)

**Kimberly Schoppa**, Fairfax County Fire And Rescue, VA [U]  
(Alt. to Kim Klaren)

**Daniel Silvestri**, 911 Safety Equipment LLC, PA [IM]  
(Alt. to Steve L. Lakey)

**Douglas Sloan**, Honeywell First Responder Products, NY [M]  
(Alt. to James A. Walter)

**Grace G. Stull**, International Personnel Protection, Inc., TX [M]  
(Alt. to Jeffrey O. Stull)

**Jay L. Tarley**, National Institute for Occupational Safety & Health, WV [E]  
(Alt. to William E. Haskell, III)

**Daniel J. Theriault**, U.S. Department of the Navy, FL [RT]  
(Alt. to Allen Ira Harkness)

**Christopher R. Vaughan**, Cuba Fire Department, AL [C]  
(Alt. to R. Wendell Robison)



**Nonvoting****William R. Hamilton**, U.S. Department of Labor, DC [E]**Andrew Levinson**, U.S. Department of Labor, DC [E]  
Rep. Occupational Safety & Health Administration**Chris Farrell**, NFPA Staff Liaison

*This list represents the membership at the time the Committee was balloted on the final text of this edition. Since that time, changes in the membership may have occurred. A key to classifications is found at the back of the document.*

NOTE: Membership on a committee shall not in and of itself constitute an endorsement of the Association or any document developed by the committee on which the member serves.

**Committee Scope:** This committee shall have primary responsibility for documents on protective ensembles, except respiratory protection, that provides head, limb, hand, foot, torso, and interface protection for fire fighters and other emergency services responders during incidents involving structural fire fighting operations or proximity fire fighting operations.

Structural fire fighting operations include the activities of rescue, fire suppression, and property conservation during incidents involving fires in buildings, enclosed structures, vehicles, marine vessels, or like properties.

Proximity fire fighting operations include the activities of rescue, fire suppression, and property conservation during incidents involving commercial and military aircraft fires, bulk flammable gas fires, bulk flammable and combustible liquids fires, combustible metal fires, exotic fuel fires, and other such fires that produce very high levels of radiant heat as well as convective and conductive heat.

Additionally, this committee shall have primary responsibility for documents on the selection, care, and maintenance of structural and proximity fire fighting protective ensembles by fire and emergency services organizations and personnel.

## Contents

<b>Chapter 1 Administration</b> .....	1851– 8	8.4 Additional Requirements for Advanced Garment Element Repair. ....	1851– 30
1.1 Scope. ....	1851– 8	8.5 Helmet Element Repair. ....	1851– 31
1.2 Purpose. ....	1851– 8	8.6 Glove Element Repair. ....	1851– 31
1.3 Application. ....	1851– 8	8.7 Footwear Element Repair. ....	1851– 31
1.4 Units. ....	1851– 9	8.8 Structural Fire Fighting Hood and Proximity Fire Fighting Helmet Overcover and Proximity Fire Fighting Shroud Repair. ....	1851– 31
<b>Chapter 2 Referenced Publications</b> .....	1851– 9	8.9 Additional Requirements for Structural Fire Fighting Ensembles and Proximity Fire Fighting Ensembles with Optional Liquid and Particulate Contaminant Protection. ....	1851– 31
2.1 General. ....	1851– 9	<b>Chapter 9 Storage</b> .....	1851– 31
2.2 NFPA Publications. ....	1851– 9	9.1 All Ensembles and Ensemble Elements. ....	1851– 31
2.3 Other Publications. ....	1851– 9	<b>Chapter 10 Retirement, Disposition, and Special Incident Procedure</b> .....	1851– 31
2.4 References for Extracts in Mandatory Sections. (Reserved) .....	1851– 9	10.1 Retirement. ....	1851– 31
<b>Chapter 3 Definitions</b> .....	1851– 9	10.2 Disposition of Retired Elements. ....	1851– 32
3.1 General. ....	1851– 9	10.3 Special Incident Procedure. ....	1851– 32
3.2 NFPA Official Definitions. ....	1851– 9	<b>Chapter 11 Verification</b> .....	1851– 32
3.3 General Definitions. ....	1851– 10	11.1 General. ....	1851– 32
<b>Chapter 4 Program</b> .....	1851– 13	11.2 Verification Program. ....	1851– 34
4.1 General. ....	1851– 13	11.3 Inspection and Testing. ....	1851– 34
4.2 Program Organization for Structural Fire Fighting Ensembles and Ensemble Elements and Proximity Fire Fighting Ensembles and Ensemble Elements. ....	1851– 14	11.4 Organization or ISP Quality Management Program. ....	1851– 37
4.3 Records. ....	1851– 15	<b>Chapter 12 Test Procedures</b> .....	1851– 38
4.4 Manufacturer’s Instructions. ....	1851– 16	12.1 Light Evaluation of Hood Particulate- Blocking Layers. ....	1851– 38
4.5 Protecting the Public and Personnel from Exposure to Contaminated PPE. ....	1851– 16	12.2 Smoke Evaluation of Hood Particulate- Blocking Layers. ....	1851– 38
4.6 Reporting Personal Protective Equipment Health and Safety Concerns. ....	1851– 16	12.3 Water Penetration Barrier Evaluation. ....	1851– 41
<b>Chapter 5 Selection</b> .....	1851– 16	12.4 Chemical Decontamination Efficacy Test. ....	1851– 42
5.1 Selection and Purchase. ....	1851– 16	12.5 Biological Decontamination Efficacy Test. ....	1851– 44
<b>Chapter 6 Inspection</b> .....	1851– 17	12.6 Semi-Volatile Organic Compound Contained Specimen Preparation, Extraction, and Analysis. ....	1851– 46
6.1 General. ....	1851– 17	12.7 Heavy Metal Contaminated Specimen Preparation, Extraction, and Analysis. ....	1851– 48
6.2 Routine Inspection. ....	1851– 17	12.8 Bacterial Contaminated Specimen Preparation, Extraction, and Analysis. ....	1851– 50
6.3 Advanced Inspection. ....	1851– 19	12.9 Preparation and Handling of Contaminated Specimens and Surrogate Clothing. ....	1851– 50
6.4 Complete Liner Inspection. ....	1851– 20	<b>Annex A Explanatory Material</b> .....	1851– 63
<b>Chapter 7 Cleaning and Decontamination</b> .....	1851– 21	<b>Annex B Informational References</b> .....	1851– 106
7.1 General. ....	1851– 21	<b>Index</b> .....	1851– 108
7.2 Preliminary Exposure Reduction. ....	1851– 24		
7.3 Advanced Cleaning. ....	1851– 24		
7.4 Disinfection or Sanitization and Biological Decontamination. ....	1851– 27		
7.5 Specialized Cleaning. ....	1851– 28		
<b>Chapter 8 Repair</b> .....	1851– 29		
8.1 Requirements for All Ensembles and Ensemble Elements. ....	1851– 29		
8.2 Requirements for Both Basic and Advanced Garment Element Repair. ....	1851– 29		
8.3 Additional Requirements for Basic Garment Element Repair. ....	1851– 30		

NFPA 1851

Standard on

## Selection, Care, and Maintenance of Protective Ensembles for Structural Fire Fighting and Proximity Fire Fighting

2020 Edition

**IMPORTANT NOTE:** This NFPA document is made available for use subject to important notices and legal disclaimers. These notices and disclaimers appear in all publications containing this document and may be found under the heading “Important Notices and Disclaimers Concerning NFPA Standards.” They can also be viewed at [www.nfpa.org/disclaimers](http://www.nfpa.org/disclaimers) or obtained on request from NFPA.

**UPDATES, ALERTS, AND FUTURE EDITIONS:** New editions of NFPA codes, standards, recommended practices, and guides (i.e., NFPA Standards) are released on scheduled revision cycles. This edition may be superseded by a later one, or it may be amended outside of its scheduled revision cycle through the issuance of Tentative Interim Amendments (TIAs). An official NFPA Standard at any point in time consists of the current edition of the document, together with all TIAs and Errata in effect. To verify that this document is the current edition or to determine if it has been amended by TIAs or Errata, please consult the National Fire Codes® Subscription Service or the “List of NFPA Codes & Standards” at [www.nfpa.org/docinfo](http://www.nfpa.org/docinfo). In addition to TIAs and Errata, the document information pages also include the option to sign up for alerts for individual documents and to be involved in the development of the next edition.

**NOTICE:** An asterisk (\*) following the number or letter designating a paragraph indicates that explanatory material on the paragraph can be found in Annex A.

A reference in brackets [ ] following a section or paragraph indicates material that has been extracted from another NFPA document. Extracted text may be edited for consistency and style and may include the revision of internal paragraph references and other references as appropriate. Requests for interpretations or revisions of extracted text shall be sent to the technical committee responsible for the source document.

Information on referenced and extracted publications can be found in Chapter 2 and Annex B.

### Chapter 1 Administration

#### 1.1 Scope.

- △ 1.1.1 This standard shall specify the minimum selection, care, and maintenance requirements for structural fire fighting protective ensembles and the individual ensemble elements that include garments, helmets, gloves, footwear, and interface components that are compliant with NFPA 1971.
- △ 1.1.2 This standard shall also specify the minimum selection, care, and maintenance requirements for proximity fire fighting protective ensembles and the individual ensemble elements that include garments, helmets, gloves, footwear, and interface components that are compliant with NFPA 1971.
- △ 1.1.3 This standard shall also specify requirements for both structural fire fighting and proximity fire fighting protective ensembles, ensemble elements, clothing, and equipment certified as compliant with previous editions of NFPA 1971.

1.1.4 This standard shall also specify the minimum selection, care, and maintenance requirements for structural fire fighting protective ensembles with optional liquid and particulate contaminant protection and for proximity fire fighting protective ensembles with optional liquid and particulate contaminant protection.

1.1.5 This standard shall not specify requirements for other organizational programs such as appropriate use of structural fire fighting or proximity fire fighting protective ensembles for training, for operations, or for infection control, because these programs are under the jurisdiction of other NFPA standards.

- △ 1.1.6 This standard shall not apply to protective ensembles or protective clothing that are compliant with NFPA 1951, NFPA 1977, NFPA 1991, NFPA 1992, NFPA 1994, and NFPA 1999.

1.1.7 This standard shall not be construed as addressing all the safety concerns associated with the use of compliant protective ensembles or ensemble elements. It shall be the responsibility of the persons and organizations that use compliant protective ensembles or ensemble elements to establish safety and health practices and to determine the applicability of regulatory limitations prior to use.

1.1.8 This standard shall not be construed as addressing all the safety concerns, if any, associated with the use of this standard by testing or repair facilities. It shall be the responsibility of the persons and organizations that use this standard to conduct testing of protective ensembles or ensemble elements to establish safety and health practices and to determine the applicability of regulatory limitations prior to using this standard for any designing, manufacturing, and testing.

1.1.9 Nothing herein shall restrict any jurisdiction from exceeding these minimum requirements.

#### 1.2 Purpose.

1.2.1 The purpose of this standard shall be to establish a program for structural fire fighting protective ensembles and ensemble elements and for proximity fire fighting protective ensembles and ensemble elements to reduce the safety risks and potential health risks associated with poorly maintained, contaminated, or damaged protective ensembles and ensemble elements.

1.2.2 The purpose of this standard shall also be to establish basic criteria for selection, inspection, cleaning, decontamination, repair, storage, and retirement of structural fire fighting protective ensembles or ensemble elements and proximity fire fighting protective ensembles or ensemble elements.

#### 1.3 Application.

- △ 1.3.1 This standard shall apply to structural fire fighting and proximity fire fighting ensembles and ensemble elements certified as compliant with NFPA 1971.
- △ 1.3.2 This standard shall also apply to structural fire fighting ensembles and ensemble elements and proximity fire fighting ensembles and ensemble elements certified as compliant with the previous editions of NFPA 1971.

1.3.2.1 This standard shall also apply to structural fire fighting protective ensembles with optional liquid and particulate contaminant protection and to proximity fire fighting protec-

tive ensembles with optional liquid and particulate contaminant protection.

**1.3.3** This standard shall not apply to other organizational programs such as appropriate use of structural fire fighting or proximity fire fighting protective ensembles for training, operations, or infection control, because these programs are under the jurisdiction of other NFPA standards.

**1.3.4** This standard shall not apply to respiratory protective equipment other than where such equipment interfaces with structural fire fighting protective ensembles or proximity fire fighting protective ensembles with the optional liquid and particulate contaminant protection.

**1.3.5** The requirements of this standard shall not apply to accessories attached to any element of the structural fire fighting protective ensemble unless specifically addressed herein.

#### 1.4 Units.

**1.4.1** In this standard, values for measurement are followed by an equivalent in parentheses, but only the first stated value shall be regarded as the requirement.

**1.4.2** Equivalent values in parentheses shall not be considered as the requirement because these values are approximate.

### Chapter 2 Referenced Publications

**2.1 General.** The documents or portions thereof listed in this chapter are referenced within this standard and shall be considered part of the requirements of this document.

**▲ 2.2 NFPA Publications.** National Fire Protection Association, 1 Batterymarch Park, Quincy, MA 02169-7471.

NFPA 600, *Standard on Facility Fire Brigades*, 2015 edition.

NFPA 1500™, *Standard on Fire Department Occupational Safety, Health, and Wellness Program*, 2018 edition.

NFPA 1951, *Standard on Protective Ensembles for Technical Rescue Incidents*, 2013 edition.

NFPA 1971, *Standard on Protective Ensembles for Structural Fire Fighting and Proximity Fire Fighting*, 2018 edition.

NFPA 1977, *Standard on Protective Clothing and Equipment for Wildland Fire Fighting*, 2016 edition.

NFPA 1991, *Standard on Vapor-Protective Ensembles for Hazardous Materials Emergencies and CBRN Terrorism Incidents*, 2016 edition.

NFPA 1992, *Standard on Liquid Splash-Protective Ensembles and Clothing for Hazardous Materials Emergencies*, 2018 edition.

NFPA 1994, *Standard on Protective Ensembles for First Responders to Hazardous Materials Emergencies and CBRN Terrorism Incidents*, 2018 edition.

NFPA 1999, *Standard on Protective Clothing and Ensembles for Emergency Medical Operations*, 2018 edition.

#### 2.3 Other Publications.

**■ 2.3.1 AATCC Publications.** American Association of Textile Chemists and Colorists, P.O. Box 12215, Research Triangle Park, NC 27709.

AATCC 135, *Dimensional Changes of Fabrics after Home Laundering*, 2004.

AATCC 198, *Horizontal Wicking of Textiles*, 2013.

**■ 2.3.2 ASTM Publications.** ASTM International, 100 Barr Harbor Drive, P.O. Box C700, West Conshohocken, PA 19428-2959.

ASTM D2261, *Standard Test Method for Tearing Strength of Fabrics by the Tongue (Single Rip) Procedure (Constant-Rate-of-Extension Tensile Testing Machine)*, 2013, reapproved 2017e1.

ASTM D5034, *Standard Test Method for Breaking Strength and Elongation of Textile Fabrics (Grab Test)*, 2017.

ASTM E2274, *Standard Test Method for Evaluation of Laundry Sanitizers and Disinfectants*, 2016.

ASTM E2406, *Standard Test Method for Evaluation of Laundry Sanitizers and Disinfectants for Use in High Efficiency Washing Operations*, 2016.

**▲ 2.3.3 ISO Publications.** International Organization for Standardization, ISO Central Secretariat, BIBC II, Chemin de Blandinnet 8, CP 401, 1214 Vernier, Geneva, Switzerland.

ISO 17011, *Conformity assessment — General requirements for accreditation bodies accrediting conformity assessment bodies*, 2004.

ISO/IEC 17025, *General requirements for the competence of testing and calibration laboratories*, 2005.

ISO/IEC 17065, *Conformity assessment — Requirements for bodies certifying products, processes and services*, 2012.

**2.3.4 U.S. Government Publications.** U.S. Government Publishing Office, 732 North Capitol Street, NW, Washington, DC 20401-0001.

Title 29, Code of Federal Regulations, Part 1910.1030, “Bloodborne Pathogens.”

**▲ 2.3.5 Other Publications.**

*Merriam-Webster’s Collegiate Dictionary*, 11th edition, Merriam-Webster, Inc., Springfield, MA, 2003.

**● 2.4 References for Extracts in Mandatory Sections. (Reserved)**

### Chapter 3 Definitions

**3.1 General.** The definitions contained in this chapter shall apply to the terms used in this standard. Where terms are not defined in this chapter or within another chapter, they shall be defined using their ordinarily accepted meanings within the context in which they are used. *Merriam-Webster’s Collegiate Dictionary*, 11th edition, shall be the source for the ordinarily accepted meaning.

#### 3.2 NFPA Official Definitions.

**3.2.1\* Approved.** Acceptable to the authority having jurisdiction.

**3.2.2\* Authority Having Jurisdiction (AHJ).** An organization, office, or individual responsible for enforcing the requirements of a code or standard, or for approving equipment, materials, an installation, or a procedure.

**3.2.3 Labeled.** Equipment or materials to which has been attached a label, symbol, or other identifying mark of an organization that is acceptable to the authority having jurisdiction and concerned with product evaluation, that maintains periodic inspection of production of labeled equipment or materials, and by whose labeling the manufacturer indicates

compliance with appropriate standards or performance in a specified manner.

**3.2.4\* Listed.** Equipment, materials, or services included in a list published by an organization that is acceptable to the authority having jurisdiction and concerned with evaluation of products or services, that maintains periodic inspection of production of listed equipment or materials or periodic evaluation of services, and whose listing states that either the equipment, material, or service meets appropriate designated standards or has been tested and found suitable for a specified purpose.

**3.2.5 Shall.** Indicates a mandatory requirement.

**3.2.6 Should.** Indicates a recommendation or that which is advised but not required.

**3.2.7 Standard.** An NFPA Standard, the main text of which contains only mandatory provisions using the word “shall” to indicate requirements and that is in a form generally suitable for mandatory reference by another standard or code or for adoption into law. Nonmandatory provisions are not to be considered a part of the requirements of a standard and shall be located in an appendix, annex, footnote, informational note, or other means as permitted in the NFPA Manuals of Style. When used in a generic sense, such as in the phrase “standards development process” or “standards development activities,” the term “standards” includes all NFPA Standards, including Codes, Standards, Recommended Practices, and Guides.

### 3.3 General Definitions.

**3.3.1 Accessory/Accessories.** An item, or items, that could be attached to a certified product but that are not necessary for the certified product to meet the requirements of the standard.

**3.3.2 Advanced Cleaning.** See 3.3.12.1, Advanced Cleaning.

**3.3.3 Biological Terrorism Agents.** Liquid or particulate agents that can consist of a biologically derived toxin or pathogen to inflict lethal or incapacitating casualties.

**3.3.4 Body Fluids.** Fluids that are produced by the body, including, but not limited to, blood, semen, mucus, feces, urine, vaginal secretions, breast milk, amniotic fluids, cerebrospinal fluid, synovial fluid, and pericardial fluid.

**3.3.5\* Carcinogen/Carcinogenic.** A cancer-causing substance that is identified in one of several published lists, including, but not limited to, those prepared by the U.S. National Toxicology Program, the International Agency for Research on Cancer (IARC), the National Institute for Occupational Safety and Health (NIOSH), and the American Conference of Governmental Industrial Hygienists (ACGIH).

**3.3.6 Care.** Cleaning and storage of protective clothing and equipment.

**3.3.7 CBRN.** An abbreviation for chemicals, biological agents, and radiological particulate hazards. (See also 3.3.8, *CBRN Terrorism Agents*.)

**3.3.8\* CBRN Terrorism Agents.** Chemicals, biological agents, and radiological particulates that could be released as the result of a terrorist attack. (See also 3.3.3, *Biological Terrorism Agents*; 3.3.11, *Chemical Terrorism Agents*; 3.3.81, *Radiological Particulate Terrorism Agents*; and 3.3.109, *Toxic Industrial Chemicals*.)

**3.3.9 Certification/Certified.** A system whereby a certification organization determines that a manufacturer has demonstrated the ability to produce a product that complies with the requirements of a specific standard(s), authorizes the manufacturer to use a label on listed products that comply with the requirements of that standard(s), and establishes a follow-up program conducted by the certification organization as a check on the methods the manufacturer uses to determine continued compliance of labeled and listed products with the requirements of that standard(s).

**3.3.10 Char.** The formation of a brittle residue when material is exposed to thermal energy.

**3.3.11 Chemical Terrorism Agents.** Liquid, solid, gaseous, and vapor chemical warfare agents and toxic industrial chemicals used to inflict lethal or incapacitating casualties, generally on a civilian population as a result of a terrorist attack.

**3.3.12\* Cleaning.** The act of removing soiling and contamination from ensembles and ensemble elements by mechanical, chemical, thermal, or combined processes.

**3.3.12.1\* Advanced Cleaning.** The act of removing both soiling and contamination generally associated with products of combustion.

**3.3.12.2\* Specialized Cleaning.** The act of removing hazardous materials, soiling associated with body fluids, or other forms of contamination.

**N 3.3.13\* Cleaning Facility.** An entity, location, or site engaged in the cleaning of ensemble elements that includes an element manufacturer verified in cleaning, a verified cleaner, a verified organization, or a verified ISP.

**3.3.14 Coat.** See 3.3.94, Structural Fire Fighting Protective Coat, and 3.3.71, Proximity Fire Fighting Protective Coat.

**Δ 3.3.15\* Contamination.** The accumulation of products of combustion and other hazardous materials on or in an ensemble element that includes carcinogenic, toxic, corrosive, or allergy-causing chemicals, body fluids, infectious microorganisms, or CBRN terrorism agents.

**3.3.16 Coverall.** See 3.3.95, Structural Fire Fighting Protective Coverall, and 3.3.72, Proximity Fire Fighting Protective Coverall.

**3.3.17 Craze.** The appearance of fine cracks in the surface of a helmet shell or other smooth surface of an ensemble element.

**3.3.18 Cross-Contamination.** The transfer of contamination from one item to another or to the environment.

**3.3.19 Crown.** The portion of the helmet that covers the head above the reference plane.

**3.3.20 Crown Straps.** The part of the helmet suspension that passes over the head.

**Δ 3.3.21\* Decontamination.** The act of removing contamination from or neutralizing contamination in protective clothing and equipment. (See also 3.3.12, *Cleaning*.)

**3.3.22\* Disinfectant.** A type of antimicrobial agent that destroys or irreversibly inactivates fungi and bacteria, but not necessarily their spores, on inanimate surfaces and objects.

- 3.3.23\* Drag Rescue Device.** A component integrated within the protective coat element to aid in the rescue of an incapacitated fire fighter.
- 3.3.24 DRD.** See 3.3.23, Drag Rescue Device.
- 3.3.25 Ear Covers.** An interface component of the protective helmet element that provides limited protection to the helmet/coat interface area.
- 3.3.26 Elasticity.** The ability of a material to return to its original form after being stretched.
- 3.3.27 Elements.** See 3.3.32, Ensemble Elements.
- 3.3.28 Embrittlement.** The hardening of a material that makes it susceptible to easy fracture.
- 3.3.29\* Emergency Medical Operations.** Delivery of emergency patient care, including patient transportation, provided prior to arrival at a hospital or other health care facility.
- 3.3.30 Energy Absorbing System.** Materials or systems used to attenuate impact energy.
- ▲ **3.3.31 Ensemble.** See 3.3.96, Structural Fire Fighting Protective Ensemble, and 3.3.73, Proximity Fire Fighting Protective Ensemble.
- 3.3.32\* Ensemble Elements.** The compliant products that provide protection to the upper and lower torso, arms, legs, head, hands, and feet.
- 3.3.33 Faceshield.** The component of the helmet that provides limited protection to a portion of the wearer's face. Not primary eye protection.
- 3.3.34 Field Evaluation.** The nonlaboratory assessment of an ensemble, ensemble element, or item.
- 3.3.35 Fit.** The quality, state, and manner in which clothing and equipment, when worn, relate to the human body.
- 3.3.36\* Flame Resistance (Protective Clothing and Equipment).** The property of a material whereby combustion is prevented, terminated, or inhibited following the application of a flaming or nonflaming source of ignition, with or without subsequent removal of the ignition source. (See also 3.3.51, *Inherent Flame Resistance*.)
- 3.3.37 Footwear.** See 3.3.98, Structural Fire Fighting Protective Footwear, and 3.3.75, Proximity Fire Fighting Protective Footwear.
- 3.3.38 Functional.** The ability of an ensemble element or component of an ensemble element to continue to be utilized for its intended purpose.
- 3.3.39 Garment.** See 3.3.99, Structural Fire Fighting Protective Garments, and 3.3.76, Proximity Fire Fighting Protective Garments.
- 3.3.40 Gauntlet.** An interface component of the protective glove element that provides limited protection to the coat/glove interface area.
- 3.3.41 Glove.** See 3.3.100, Structural Fire Fighting Protective Glove, and 3.3.77, Proximity Fire Fighting Protective Glove.
- 3.3.42 Glove Wristlet.** See 3.3.119, Wristlet.
- 3.3.43\* Goggles.** Ensemble element or component that provides limited protection to the wearer's eyes. Goggles might or might not provide primary protection.
- **3.3.44\* Gross Decontamination.** A term used in the hazardous materials response industry to indicate the partial removal of exterior contamination from protective clothing, usually by rinsing with water, sometimes with detergent, to allow for the safe exit of the responder from the protective clothing in the contamination reduction zone of an emergency incident. (See 3.3.66, *Preliminary Exposure Reduction*.)
- 3.3.45 Hardware.** Nonfabric components of the protective clothing and equipment including, but not limited to, those made of metal or plastic.
- 3.3.46\* Hazardous Materials.** Substances (solid, liquid, or gas) that when released are capable of creating harm to people, the environment, and property.
- 3.3.47 Hazardous Materials Emergencies.** Incidents involving the release or potential release of hazardous materials.
- 3.3.48 Helmet.** See 3.3.101, Structural Fire Fighting Protective Helmet, and 3.3.78, Proximity Fire Fighting Protective Helmet.
- 3.3.49 Hood.** See 3.3.103, Structural Fire Fighting Protective Particulate-Blocking Hood, and 3.3.102, Structural Fire Fighting Protective Hood.
- 3.3.50 Independent Service Provider (ISP).** An independent third party utilized by an organization to perform advanced cleaning, advanced inspection, and repair services. In order to comply with NFPA 1851, an ISP must be verified. [See also 3.3.115, *Verified Independent Service Provider (ISP)*].
- 3.3.51 Inherent Flame Resistance.** Flame resistance that is derived from the essential characteristics of the fiber or polymer.
- 3.3.52 Integrity.** The ability of an ensemble or ensemble element to remain intact and provide continued minimum performance.
- 3.3.53 Interface Area.** An area of the body where the protective garments, helmet, gloves, footwear, or SCBA facepiece meet. Interface areas include, but are not limited to, the coat/helmet/SCBA facepiece area, the coat/trouser area, the coat/glove area, and the trouser/footwear area.
- 3.3.54\* Interface Component(s).** Any material, part, or subassembly used in the construction of the compliant product that provides limited protection to interface areas.
- 3.3.55 Liner System.** The moisture barrier and thermal barrier components as used in a garment.
- 3.3.56 Maintenance.** The inspection, service, and repair of protective clothing and equipment, including the determination for removal from service.
- 3.3.57 Major A Seam.** See 3.3.84.1, Major A Seam.
- 3.3.58 Major B Seam.** See 3.3.84.2, Major B Seam.
- 3.3.59 Manufacturer.** The entity that directs and controls any of the following: compliant product design, compliant product manufacturing, or compliant product quality assurance; or the entity that assumes the liability for the compliant product or provides the warranty for the compliant product.

**3.3.60 Manufacturer-Trained Organization.** See 3.3.64.1, *Manufacturer-Trained Organization*.

**3.3.61 Melt.** A response to heat by a material resulting in evidence of flowing or dripping.

**3.3.62 Minor Seam.** See 3.3.84.3, *Minor Seam*.

**3.3.63 Moisture Barrier.** The component of an ensemble element or item that principally prevents the transfer of liquids.

**3.3.64\* Organization.** The entity that provides the direct management and supervision for the emergency services personnel.

**3.3.64.1 Manufacturer-Trained Organization.** A non-verified organization trained by an element manufacturer of the same element type to conduct any one or a combination of advanced cleaning, advanced inspection, and basic repair on the organization's elements.

Δ **3.3.64.2 Verified Organization.** An organization verified by a third-party certification organization to conduct advanced cleaning, advanced inspection and sanitization, basic repair, and advanced repair on any organization's elements.

**3.3.65 Outer Shell.** The outermost component of an ensemble element or item, not including trim, hardware, reinforcing material, pockets, wristlet material, accessories, fittings, or suspension systems.

N **3.3.66\* Preliminary Exposure Reduction.** Techniques for reducing soiling and contamination levels on the exterior of the ensemble or ensemble element following incident operations.

N **3.3.67\* Products of Combustion.** The end product when fuels, such as hydrocarbons and materials, remain after the process of combustion in a fire.

**3.3.68 Protective Clothing.** See 3.3.96, *Structural Fire Fighting Protective Ensemble*, and 3.3.73, *Proximity Fire Fighting Protective Ensemble*.

**3.3.69 Protective Ensemble.** See 3.3.96, *Structural Fire Fighting Protective Ensemble*, and 3.3.73, *Proximity Fire Fighting Protective Ensemble*.

**3.3.70 Proximity Fire Fighting.** Specialized fire fighting operations that can include the activities of rescue, fire suppression, and property conservation at incidents involving fires producing high levels of radiant heat as well as conductive and convective heat.

**3.3.71 Proximity Fire Fighting Protective Coat.** The element of the protective ensemble that provides protection to the upper torso and arms, excluding the hands and head.

**3.3.72 Proximity Fire Fighting Protective Coverall.** The element of the protective ensemble that provides protection to the torso, arms, and legs, excluding the head, hands, and feet.

**3.3.73\* Proximity Fire Fighting Protective Ensemble.** Multiple elements of compliant protective clothing and equipment that when worn together provide protection from some risks, but not all risks, of emergency incident operations.

**3.3.74 Proximity Fire Fighting Protective Ensemble with Optional Liquid and Particulate Contamination Protection.** A compliant proximity fire fighting protective ensemble that is

also certified as an entire ensemble to meet the optional requirements for protection from liquid and particulate contaminants.

**3.3.75 Proximity Fire Fighting Protective Footwear.** The element of the protective ensemble that provides protection to the foot, ankle, and lower leg.

**3.3.76 Proximity Fire Fighting Protective Garments.** The coat, trouser, and coverall elements of the protective ensemble.

**3.3.77 Proximity Fire Fighting Protective Glove.** The element of the protective ensemble that provides protection to the hand and wrist.

**3.3.78 Proximity Fire Fighting Protective Helmet.** The element of the protective ensemble that provides protection to the head.

**3.3.79 Proximity Fire Fighting Protective Shroud.** The component of the helmet that provides limited protection to the helmet/coat interface area.

**3.3.80 Proximity Fire Fighting Protective Trouser.** The element of the protective ensemble that provides protection to the lower torso and legs, excluding the ankles and feet.

**3.3.81\* Radiological Particulate Terrorism Agents.** Particles that emit ionizing radiation in excess of normal background levels, used to inflict lethal or incapacitating casualties, generally on a civilian population as a result of terrorist attack.

**3.3.82 Retirement.** The process of permanently removing an ensemble element from emergency operations service in the organization.

•  
N **3.3.83\* Sanitizer.** A type of antimicrobial agent that is used to reduce, but not necessarily eliminate, microorganisms from the inanimate environment to levels considered safe as determined by public health codes or regulations.

**3.3.84 Seam.** Any permanent attachment of two or more materials in a line formed by joining the separate material pieces.

**3.3.84.1\* Major A Seam.** Outermost layer seam assemblies where rupture could reduce the protection of the garment by exposing the garment's inner layers.

**3.3.84.2\* Major B Seam.** Inner layer seam assemblies where rupture could reduce the protection of the garment by exposing the next layer of the garment, the wearer's station/work uniform, other clothing, or skin.

**3.3.84.3 Minor Seam.** Remaining seam assemblies that are not classified as Major A or Major B seams.

**3.3.85 Selection.** The process of determining what protective clothing and equipment (PCE) is necessary for protection of fire and emergency services response personnel from an anticipated specific hazard or other activity, the procurement of the appropriate PCE, and the choice of the proper PCE for a specific hazard or activity at an emergency incident.

**3.3.86 Separate/Separation.** A material response evidenced by splitting or delaminating.

**3.3.87 Service Life.** The period for which compliant product can be useful before retirement.

- 3.3.88 Shank.** The component of footwear that provides additional support to the instep.
- 3.3.89 Shroud.** See 3.3.79, Proximity Fire Fighting Protective Shroud.
- Δ **3.3.90\* Soiling.** The accumulation of sweat, dust, dirt, debris, and other nonhazardous materials on or in an ensemble or ensemble element that could degrade its performance or cause hygiene issues.
- 3.3.91 Specialized Cleaning.** See 3.3.12.2, Specialized Cleaning.
- 3.3.92 Stress Area.** Those areas of the garment that are subjected to more wear, including, but not limited to, crotches, knees, elbows, and shoulders.
- 3.3.93 Structural Fire Fighting.** The activities of rescue, fire suppression, and property conservation in buildings, enclosed structures, vehicles, marine vessels, or like properties that are involved in a fire or emergency situation.
- 3.3.94 Structural Fire Fighting Protective Coat.** The element of the protective ensemble that provides protection to the upper torso and arms, excluding the hands and head.
- 3.3.95 Structural Fire Fighting Protective Coverall.** The element of the protective ensemble that provides protection to the torso, arms, and legs, excluding the head, hands, and feet.
- 3.3.96\* Structural Fire Fighting Protective Ensemble.** Multiple elements of compliant protective clothing and equipment that when worn together provide protection from some risks, but not all risks, of emergency incident operations.
- 3.3.97 Structural Fire Fighting Protective Ensemble with Optional Liquid and Particulate Contaminant Protection.** A compliant structural fire fighting protective ensemble that is also certified as an entire ensemble to meet the optional requirements for protection from liquid and particulate contaminants.
- 3.3.98 Structural Fire Fighting Protective Footwear.** The element of the protective ensemble that provides protection to the foot, ankle, and lower leg.
- 3.3.99 Structural Fire Fighting Protective Garments.** The coat, trouser, and coverall elements of the protective ensemble.
- 3.3.100 Structural Fire Fighting Protective Glove.** The element of the protective ensemble that provides protection to the hand and wrist.
- 3.3.101 Structural Fire Fighting Protective Helmet.** The element of the protective ensemble that provides protection to the head.
- 
- N **3.3.102 Structural Fire Fighting Protective Hood.** The interface element of a protective ensemble that provides limited protection to the coat/helmet/SCBA facepiece interface area.
- N **3.3.103\* Structural Fire Fighting Protective Particulate-Blocking Hood.** A structural fire fighting protective hood that reduces particulate penetration.
- 3.3.104 Structural Fire Fighting Protective Trousers.** The element of the protective ensemble that provides protection to the lower torso and legs, excluding the ankles and feet.
- 3.3.105 Suspension.** The energy attenuating system of the helmet that is made up of the headband and crown strap.
- 3.3.106 Tensile Strength.** The force at which a fiber or fabric will break when pulled in one dimension.
- 3.3.107 Textile Fabric.** A planar structure consisting of yarns or fibers.
- 3.3.108 Thermal Barrier.** The component of an ensemble element or item that principally provides thermal protection.
- 3.3.109 Toxic Industrial Chemicals.** Highly toxic solid, liquid, or gaseous chemicals that have been identified as mass casualty threats that could be used to inflict casualties, generally on a civilian population, during a terrorist attack.
- 3.3.110 Trim.** See 3.3.117, Visibility Markings.
- 3.3.111 Trouser.** See 3.3.104, Structural Fire Fighting Protective Trousers, and 3.3.80, Proximity Fire Fighting Protective Trousers.
- 3.3.112\* Universal Precautions.** An approach to infection control in which human blood and certain human body fluids are treated as if known to be infectious for HIV, HBV, and other bloodborne pathogens.
- 3.3.113 Utility Sink.** A separate sink used for cleaning ensembles and ensemble elements.
- N **3.3.114 Verified Cleaner.** An independent cleaning service verified by a third-party certification organization to conduct advanced cleaning and sanitization.
- Δ **3.3.115 Verified Independent Service Provider (ISP).** An independent service provider verified by a third-party certification organization to conduct advanced inspection, advanced cleaning and sanitization, basic repair, and advanced repair service.
- 3.3.116 Verified Organization.** See 3.3.64.2, Verified Organization.
- 3.3.117 Visibility Markings.** Retroreflective and fluorescent conspicuity enhancements. Retroreflective enhancements improve nighttime conspicuity, and fluorescent enhancements improve daytime conspicuity.
- 3.3.118 Winter Liner.** An optional component layer that provides added insulation against cold.
- 3.3.119 Wristlet.** The interface component of the protective element or item that provides limited protection to the coat/glove interface area.

## Chapter 4 Program

### Δ 4.1 General.

**4.1.1\*** The organization shall develop and implement a program for the selection, care, and maintenance of structural fire fighting ensembles and ensemble elements and proximity fire fighting ensembles and ensemble elements used by the members of the organization in the performance of their assigned functions.

**4.1.2** This program shall have the goal of providing structural fire fighting ensembles and ensemble elements and proximity fire fighting ensembles and ensemble elements that are suitable for the intended use.



ble and appropriate for the intended use; maintaining such protective ensembles and ensemble elements in a safe, usable condition to provide the intended protection to the user; removing from use such protective ensembles and ensemble elements that could cause or contribute to user injury, illness, or death because of their condition; and reconditioning, repairing, or retiring such protective ensembles and ensemble elements.

**4.1.3** Where this program for the selection, care, and maintenance of structural and proximity fire fighting protective ensembles and ensemble elements is part of an organization's overall program on protective clothing and protective equipment, the portion of the organization's overall program that affects structural and proximity fire fighting protective ensembles and ensemble elements shall be in accordance with Section 4.2.

**4.2 Program Organization for Structural Fire Fighting Ensembles and Ensemble Elements and Proximity Fire Fighting Ensembles and Ensemble Elements.**

**4.2.1** The organization's program specified in Section 4.1 shall incorporate at least the requirements in Chapters 4 through 12 of this standard.

**4.2.2\*** The organization shall develop written standard operating procedures (SOPs) that shall identify and define the various parts of the program and the various roles and responsibilities of the organization and of the members in the program parts specified in Table 4.2.2.

**4.2.3\*** The organization shall not add or permit accessories to be added to any ensemble or ensemble element prior to the organization requesting approval in writing and receiving written approval from the ensemble or ensemble element manufacturer for each specific accessory.

**4.2.3.1\*** The organization shall not add or permit accessories to be added to any ensemble or ensemble element where the organization's request for approval has been responded to in writing with a disapproval from the ensemble or ensemble element manufacturer.

**4.2.3.2\*** In the event that the organization cannot make contact with the ensemble or ensemble element manufacturer for a specific accessory to be used on the ensemble or ensemble element, the organization shall be permitted to evaluate the accessory for attachment to an ensemble or ensemble

element using recognized tests to determine that the accessory does not degrade the performance of the ensemble or ensemble element.

**4.2.3.3\*** In the event the organization's written requests for permission have not received a reply from the ensemble or ensemble element manufacturer for a specific accessory to be used on the ensemble or ensemble element, the organization shall be permitted to evaluate the accessory for attachment to an ensemble or ensemble element using recognized tests to determine that the accessory does not degrade the performance of the ensemble or ensemble element.

**4.2.4\*** The organization shall use one or any combination thereof of the following to perform advanced cleaning, sanitization or disinfection, advanced inspection, and repair services of ensembles and ensemble elements (see Table 4.2.4):

- (1) Manufacturer verified in cleaning
- (2) Verified organization
- (3) Verified independent service provider (ISP)
- (4) Verified cleaner
- (5) Manufacturer-trained organization for the organization's ensembles and ensemble elements only
- (6) Ensemble or ensemble element manufacturer

**Δ 4.2.4.1** Verified organizations, verified ISPs, manufacturers verified in cleaning, and verified cleaners shall meet the requirements of Chapter 11 and shall be verified by a third-party certification organization.

**N 4.2.4.1.1** Manufacturers verified in cleaning shall meet the cleaning requirements of Chapter 11 and shall be verified by a third-party certification organization.

**N 4.2.4.1.2** Verified cleaners shall meet the cleaning and quality management requirements of Chapter 11 and shall be verified by a third-party certification organization.

**4.2.4.2\*** Where the organization is a verified organization, uses a verified ISP, or uses a verified cleaner, approval from the element manufacturer shall not be required.

**Δ 4.2.4.3\*** Verified organizations and verified ISPs shall receive written verification from the third-party certification organization to conduct garment element advanced cleaning, advanced inspection, and advanced repair services.

**N 4.2.4.3.1\*** Verified cleaners shall receive written verification from the third-party certification organization to conduct garment element advanced cleaning.

**N 4.2.4.3.2** Manufacturers verified in cleaning shall receive written verification from the third-party certification organization to conduct garment element advanced cleaning.

**• 4.2.4.4** All garment advanced repairs shall be conducted by the garment manufacturer, a verified organization, or a verified ISP.

**Δ 4.2.4.5\*** Manufacturer-trained organizations shall meet the training requirements in this section and shall be permitted to perform the activities identified in Table 4.2.4 for manufacturer-trained organizations.

**N 4.2.4.5.1\*** Training shall be provided by an element manufacturer of the same element type, a verified ISP, a verified organization, a verified cleaner, or any combination thereof.

**Δ Table 4.2.2 Required Program Parts for Structural and Proximity Fire Fighting Protective Ensembles and Elements**

Program Part	Chapter/Section of NFPA 1851
Records	Section 4.3
Protecting the public and personnel from exposure to contaminated PPE	Section 4.5
Selection	Chapter 5
Inspection	Chapter 6
Cleaning	Chapter 7
Repair	Chapter 8
Storage	Chapter 9
Retirement, disposition, and special incident procedures	Chapter 10

**N** Table 4.2.4 Responsibilities for Garment Element Inspection, Cleaning, and Repair

	Manufacturer Verified in Cleaning	Verified ISP or Verified Organization	Verified Cleaner	Manufacturer- Trained Organization	User	Ensemble or Ensemble Element Manufacturer
Routine inspections (Section 6.2)					X	
Preliminary exposure reduction (Section 7.2)					X	
Advanced inspection (Section 6.3)	X	X		X		X
Complete liner inspection (Section 6.4)	X	X		X		X
Advanced cleaning (Section 7.3)	X	X	X	X		
Sanitization or disinfection (Section 7.4)	X	X	X	X		
Specialized cleaning (Section 7.5)	X	X	X	X		
Basic repair (Sections 8.2 and 8.3)	X	X		X		X
Advanced repair (Sections 8.2 and 8.4)	X	X				X
Training for cleaning	X	X	X			X
Training for repairs	X	X				X
Training for inspection	X	X				X

**N 4.2.4.5.2\*** Training shall be consistent with the requirements and information provided in this standard and shall incorporate at least the following:

- (1) Program (*see Section 4.2*)
- (2) Records (*see Section 4.3*)
- (3) Protecting the public and personnel from exposure to contaminated PPE (*see Section 4.5*)
- (4) Selection (*see Chapter 5*)
- (5) Inspection (*see Chapter 6*)
- (6) Cleaning (*see Chapter 7*)
- (7) Repair (*see Chapter 8*)
- (8) Storage (*see Chapter 9*)
- (9) Retirement, disposition, and special incident procedures (*see Chapter 10*)
- (10) Specific instructions, parameters or procedures applicable to ensembles or ensemble elements with unique properties or performance as necessary

**N 4.2.4.5.3\*** The entity conducting the training shall provide documentation that the organization has received the required training.

**N 4.2.4.5.4** Organizations shall obtain and complete within one year of the edition issuance date the training required in 4.2.4.5.2 each time a new edition of NFPA 1851 is issued or there is a change in personnel overseeing or performing the required aspects of an organization's program.

**N 4.2.4.5.5** Organizations shall consult with an ensemble or ensemble element manufacturer when additional training is necessary for special requirements specific to products, components, or materials that are unique to a manufacturer.

**4.2.5\*** The organization shall develop specific criteria for removal of protective clothing and equipment from service, in accordance with Chapter 10, Retirement, Disposition, and Special Incident Procedure. The criteria for retirement shall

include, but not be limited to, issues that are specific to the ensembles or ensemble elements being used by the organization, the manufacturers' instructions, and the experience of the organization.

### 4.3 Records.

**4.3.1\*** The organization shall compile and maintain records on its structural fire fighting protective ensembles and ensemble elements and proximity fire fighting protective ensembles and ensemble elements.

**4.3.2\*** The records specified in 4.3.1 shall apply to fire fighting protective ensembles and ensemble elements that are utilized by the fire department, including rental or loaner protective ensembles and ensemble elements.

**4.3.3** At least the following records shall be kept for each protective ensemble or ensemble element:

- (1) Person to whom element is issued
- (2) Date and condition when issued
- (3) Manufacturer and model name or design
- (4) Manufacturer's identification number, lot number, or serial number
- (5) Month and year of manufacture
- (6) Date(s) and findings of advanced inspection(s)
- (7) Date(s) and findings of advanced cleaning, disinfection or sanitization, or specialized cleaning
- (8) Reason(s) for and who performed advanced cleaning, disinfection or sanitization, or specialized cleaning
- (9) Date(s) of repair(s), who performed repair(s), and brief description of repair(s)
- (10) Date of retirement
- (11) Date and method of disposal

**4.3.4** The organization shall compile and maintain records as required by 4.3.3 on fire fighting protective ensembles with

liquid and particulate contaminant protection. The records shall include a list of specific required elements and interface components necessary for structural fire fighting protective ensembles with optional liquid and particulate contaminant protection and proximity fire fighting protective ensembles with optional liquid and particulate contaminant protection.

**N 4.3.5\*** Where an organization keeps an element(s) in a rotating exchange program and does not assign it to a member, the organization shall develop a program to clean and inspect these elements and the following records shall be kept:

- (1) Manufacturer and model name or designation
- (2) Manufacturer's identification number, lot number, or serial number
- (3) Month and year of manufacture
- (4) Date(s) and findings of advanced inspection(s)
- (5) Date(s) and findings of advanced cleaning, disinfection or sanitization, or specialized cleaning
- (6) Date(s) element is returned to rotating exchange inventory
- (7) Reasons for and who performed advanced cleaning, disinfection or sanitization, or specialized cleaning
- (8) Date(s) of repair(s), who performed repair(s), and brief description of repair(s)
- (9) Date of retirement
- (10) Date and method of disposal

#### 4.4 Manufacturer's Instructions.

**4.4.1** When issuing new structural fire fighting protective ensembles and ensemble elements or proximity fire fighting protective ensembles and ensemble elements, the organization shall provide users with the instructions provided by the manufacturer on the care, use, and maintenance of the protective ensembles or ensemble elements, including any warnings provided by the manufacturer. This information shall be permitted to be delivered from the manufacturer in various formats, including, but not limited to, printed materials or instructions to access the information electronically/digitally.

**4.4.2\*** Where the manufacturer's instructions regarding the care or maintenance of the protective ensembles or elements differ from a specific requirement(s) in this standard, the manufacturer's instructions shall be followed for that requirement(s). Manufacturers shall not be permitted to override the requirements of this standard for third-party verification.

**4.4.3** The organization shall retain and make accessible to fire department personnel a copy of manufacturers' instructions regarding the care, use, and maintenance of the protective ensembles for reference purposes.

#### 4.5 Protecting the Public and Personnel from Exposure to Contaminated PPE.

**4.5.1** The organization shall develop written SOPs that minimize the public's and the fire department personnel's exposure to soiled or contaminated structural or proximity fire fighting protective ensembles and ensemble elements.

**4.5.2\*** The SOPs shall require that protective ensembles or ensemble elements not be worn or stored in the living areas of fire department facilities.

**4.5.3\*** The public shall not be exposed at any time, except during emergency operations, to soiled or potentially contaminated protective ensembles or ensemble elements.

**4.5.4\*** Soiled or potentially contaminated ensembles or ensemble elements shall not be brought into the home, taken to public facilities, or transported in private vehicles.

#### 4.6 Reporting Personal Protective Equipment Health and Safety Concerns.

**4.6.1\*** The organization shall report all personal protective equipment (PPE) health and safety concerns, if caused by a known or suspected element failure, to the element manufacturer and certification organization.

**4.6.2\*** The organization shall notify the manufacturer and the certification organization in writing.

**4.6.3** The organization shall request written acknowledgment that the report of health and safety concerns was received by the element manufacturer and certification organization. Written acknowledgment must be received within 30 days of the date of the report of health and safety concerns.

## Chapter 5 Selection

### 5.1\* Selection and Purchase.

**5.1.1\*** Prior to starting the selection process of structural fire fighting ensembles and ensemble elements and proximity fire fighting ensembles and ensemble elements, the organization shall perform a risk assessment.

**N 5.1.1.1** The organization shall distinguish between the use of structural fire fighting ensembles and proximity fire fighting ensembles based on the operating area and mission responsibilities of the organization. The risk assessment shall be based on both the frequency and severity of exposure to specific hazards as a means for determining the selection of appropriate fire fighting protective ensembles.

**N 5.1.1.2** The organization shall review the risk assessment or conduct a new risk assessment at least every 2 years or under specific circumstances, including, but not limited to, the following:

- (1) When there are changes that affect the findings of the current risk assessment in terms of the specific identification of hazards or availability of fire fighting ensemble product technology
- (2) When there are changes in the organization's standard operating procedures (SOPs) for the use of structural fire fighting ensembles or proximity fire fighting ensembles
- (3) When any personal protective ensemble or ensemble elements are being considered for selection and purchase

**5.1.2** The risk assessment shall include, but not be limited to, the hazards that can be encountered by structural or proximity fire fighters based on the following:

- (1)\* Type of duties performed
- (2) Distinguishing response activities for different potential incidents
- (3) Organization's experiences
- (4) Incident operations
- (5) Geographic location and climate
- (6)\* Specific physical area of operation
- (7)\* Likelihood of or response to CBRN terrorism incident
- (8) Need for two sets of ensemble elements or spare ensemble elements

△ 5.1.3\* The organization shall review the current edition of NFPA 1971, NFPA 1994, NFPA 1500, NFPA 600, and any applicable federal or state OSHA standards relating to structural fire fighting protective ensembles and ensemble elements to determine how they affect the selection process.

△ 5.1.4\* The organization shall ensure that elements under consideration are certified as being compliant with NFPA 1971 by a third-party certification organization.

5.1.5\* Based on the risk assessment, the organization shall compile and evaluate information on the comparative strengths and weaknesses of the elements under consideration.

∇ 5.1.5.1\* Organizations shall specifically consider the tradeoffs in the level of thermal insulation versus thermal comfort or stress-related effects of the material composite in their selection of protective garments.

5.1.6\* The organization shall ensure the proper interface between ensemble elements, including, but not limited to, coat-to-hood and helmet, coat-to-pant, coat-to-glove, and pants-to-footwear. Any other specialty equipment being used shall also be considered to ensure the equipment does not interfere with the proper function and interface of the protective ensemble or ensemble elements.

∇ 5.1.6.1\* Based on the risk assessment, the organization shall ensure that eye and face protection components or separate devices are specified to provide adequate eye and face protection for each type of incident identified in the risk assessment.

5.1.7\* Where a field evaluation of an ensemble or ensemble element is conducted, the organization shall establish criteria to ensure a systematic method of comparing products in a manner related to their intended use and assessing their performance relative to the organization's expectations.

△ 5.1.8\* Where the organization develops purchase specifications, at least the following criteria shall be included:

- (1) Purchase specifications shall require that the ensemble or ensemble element(s) to be purchased shall be compliant with the current edition of NFPA 1971. Purchasers shall consider that ensembles that are certified to the optional liquid and particulate contamination protection requirement are tested and certified as ensembles and must be worn as an ensemble with all elements and interface components present as stated on the element label.
- (2)\* Where the organization selects criteria that exceed the minimum requirements of the current edition of NFPA 1971, such criteria shall be stipulated in the purchase specifications.
- (3)\* Purchase specifications shall require that submitted offers or bids include substantiation of certification for each element and model offered.
- (4)\* Where applicable, the purchase specifications shall define the process for determining proper fit.
- (5)\* The organization shall compare each bid submittal against purchase specifications.

5.1.9 Upon receipt, organizations shall inspect purchased protective ensemble element(s) to determine that they meet their specifications and that they were not damaged during shipment. Organizations shall also verify the quantity and sizes of the protective ensemble element(s) received.

5.1.10 Organizations shall examine information supplied with the products, such as instructions, warranties, and technical data.

5.1.11 Procedures shall be established for returning unsatisfactory products if the organization's specifications are not met.

## Chapter 6 Inspection

### 6.1 General.

6.1.1 Universal precautions shall be observed, as appropriate, when handling ensemble elements. At a minimum, individuals conducting inspections shall wear examination gloves that are certified to NFPA 1999. Consideration shall also be given to having individuals conducting inspections of ensemble elements wear appropriate aprons with sleeves or respirators.

△ 6.1.2 Any ensemble elements that are found to be soiled or contaminated shall be cleaned before any additional inspection is initiated. Where ensemble elements are found to be contaminated by CBRN agents, the ensemble shall be retired.

6.1.3\* The organization shall establish guidelines for its members to follow in determining if an element is soiled to an extent that cleaning is necessary.

△ 6.1.4 The organization shall determine appropriate actions to be taken if an element is found to be in need of cleaning or repair.

△ 6.1.4.1 At a minimum, any necessary cleaning shall be done in accordance with the requirements specified in Chapter 7. Where a condition exists that is beyond preliminary exposure reduction in accordance with Section 7.2, the element shall be removed from service, tagged, and referred to personnel responsible for advanced cleaning.

6.1.4.2 At a minimum, any necessary repairs shall be made in accordance with the requirements specified in Chapter 8. Where a condition exists that is beyond basic garment element repair in accordance with Section 8.3, the element shall be removed from service, tagged, and referred to personnel responsible for repair.

6.1.4.3 At a minimum, any necessary testing shall be conducted in accordance with the methods specified in Chapter 12.

### 6.2 Routine Inspection.

6.2.1 Individual members shall conduct a routine inspection of their protective ensembles and ensemble elements upon issue, at the beginning of each duty period, and after each use.

6.2.2\* The routine inspection shall include, at a minimum, the inspections specified in 6.2.2.1 through 6.2.2.7.

6.2.2.1 Coat and trouser garment elements shall be inspected for the following:

- (1) Soiling
- (2) Contamination
- (3) Physical damage such as the following:
  - (a) Rips, tears, and cuts
  - (b) Damaged or missing hardware and closure systems
  - (c) Thermal damage (such as charring, burn holes, melting, or discoloration of any layer)
- (4) Damaged or missing reflective trim

- (5) Loss of seam integrity and broken or missing stitches
- (6) Correct assembly and size compatibility of shell, liner, and the drag rescue device (DRD)

**6.2.2.2** Hood elements shall be inspected for the following:

- (1) Soiling
- (2) Contamination
- (3) Physical damage such as the following:
  - (a) Rips, tears, and cuts
  - (b) Thermal damage (such as charring, burn holes, melting, or discoloration of any layer)
- (4) Loss of face opening adjustment
- (5) Loss of seam integrity and broken or missing stitches
- (6)\* Damage to the particulate-blocking layer (particulate-blocking hoods only)

**6.2.2.3** Helmet elements shall be inspected for the following:

- (1) Soiling
- (2) Contamination
- (3) Physical damage to the shell such as the following:
  - (a) Cracks, crazing, dents, and abrasions
  - (b) Thermal damage to the shell (such as bubbling, soft spots, warping, or discoloration)
- (4) Physical damage to the earflaps such as the following:
  - (a) Rips, tears, and cuts
  - (b) Thermal damage (such as charring, burn holes, or melting)
- (5) Damaged or missing components of the suspension and retention systems
- (6)\* Damaged or missing components of the faceshield/goggle system, including discoloration, crazing, and scratches to the faceshield/goggle lens limiting visibility
- (7) Damaged or missing reflective trim
- (8) Loss of seam integrity and broken or missing stitches

**6.2.2.4** Glove elements shall be inspected for the following:

- (1) Soiling
- (2) Contamination
- (3) Physical damage such as the following:
  - (a) Rips, tears, and cuts
  - (b) Thermal damage (such as charring, burn holes, melting, or discoloration of any layer)
  - (c) Inverted glove liner
- (4) Shrinkage
- (5) Loss of elasticity or flexibility
- (6) Loss of seam integrity and broken or missing stitches

**6.2.2.5** Footwear elements shall be inspected for the following:

- (1) Soiling
- (2) Contamination
- (3) Physical damage such as the following:
  - (a) Cuts, tears, and punctures
  - (b) Thermal damage (such as charring, burn holes, melting, or discoloration of any layer)
  - (c) Exposed or deformed protective toe, protective midsole, or shank
- (4) Loss of water resistance
- (5) Closure system component damage and functionality
- (6) Loss of seam integrity and broken or missing stitches

**6.2.2.6** DRD components shall be inspected for the following:

- (1) Installation in garment
- (2) Soiling

- (3) Contamination
- (4) Physical damage such as the following:
  - (a) Cuts, tears, punctures, cracking, or splitting
  - (b) Thermal damage (such as charring, burn holes, melting, or discoloration)
  - (c) Loss of seam integrity and broken or missing stitches

**6.2.2.7** Interface components shall be inspected for the following:

- (1) Soiling
- (2) Contamination
- (3) Physical damage
- (4) Loss or reduction of properties that allow component to continue as effective interface [e.g., loss of shape or inability to remain attached to the respective element(s) where attachment is required]
- (5) Loss of seam integrity and broken or missing stitches

**6.2.3 Additional Routine Inspection Requirements for Proximity Fire Fighting Protective Ensembles and Ensemble Elements.**

**6.2.3.1** Proximity fire fighting coat and trouser garment elements shall be inspected for the following:

- (1) Loss of reflectivity
- (2) Loss of reflective coating(s)
- (3) Delamination as evidenced by separation or peeling of the outer shell

**6.2.3.2** Proximity fire fighting helmet element overcover shall be inspected for the following:

- (1) Loss of reflectivity
- (2) Loss of reflective coating(s)
- (3) Delamination as evidenced by separation or peeling of the outer shell
- (4) Damaged or missing reflective trim, if applicable
- (5) Damage and functionality of the overcover to helmet attachment

**6.2.3.3** Proximity fire fighting shrouds shall be inspected for the following:

- (1) Loss of reflectivity
- (2) Loss of reflective coating(s)
- (3) Delamination as evidenced by separation or peeling of the outer shell
- (4) If applicable, damage and functionality of the shroud-to-helmet attachment
- (5) Distortion of face opening resulting in gaps around the faceshield

**6.2.3.4** Proximity fire fighting helmet elements shall be inspected for the following:

- (1) Loss of faceshield reflectivity
- (2) Loss of shell reflectivity, if applicable

**6.2.3.5** Proximity fire fighting glove elements shall be inspected for the following:

- (1) Loss of reflectivity
- (2) Loss of reflective coating(s)

**6.2.3.6** Proximity fire fighting footwear elements shall be inspected for the following:

- (1) Loss of reflectivity
- (2) Loss of reflective coating(s)

### 6.3 Advanced Inspection.

**6.3.1** Advanced inspection and any necessary testing shall be performed by the element manufacturer, a manufacturer-trained organization, a verified organization, or a verified ISP.

**6.3.2** The member(s) of the organization who has received training in the advanced inspection of the ensembles or ensemble elements shall be responsible for performing, managing, or coordinating advanced inspections or the advanced inspection process.

**6.3.2.1\*** The ensemble or ensemble element manufacturer or a verified ISP and the organization shall determine the level of training required to perform advanced inspections. The ensemble or ensemble element manufacturer or verified ISP shall provide written verification of training. The organization shall be trained on advanced inspection procedures by either an element manufacturer or a verified ISP upon each new revision of this standard.

**6.3.2.1.1** If the organization is a verified organization, it shall be permitted to determine the level of training necessary to perform the advanced inspection without any further written verification.

**6.3.3\*** Advanced inspections of all protective ensemble elements that are issued shall be conducted annually and whenever a routine inspection determines potential damage.

**6.3.3.1** Ensemble elements that have been properly stored in accordance with Chapter 9 and are not being used are not required to be subjected to advanced inspection.

**6.3.4\*** The findings of the advanced inspection shall be documented.

**△ 6.3.5\*** The advanced inspection shall include, at a minimum, the inspections specified in 6.3.5.1 through 6.3.7.3.

**6.3.5.1\*** All separable layers of the garment elements shall be individually inspected for the following:

- (1) Soiling
- (2) Contamination
- (3)\* Physical damage to all layers, such as the following:
  - (a) Rips, tears, cuts, and abrasions
  - (b) Damaged or missing hardware
  - (c) Thermal damage (charring, burn holes, melting, discoloration of any layer)
- (4)\* Loss of moisture barrier integrity as indicated by any of the following:
  - (a) Rips, tears, cuts, or abrasions
  - (b) Discoloration
  - (c) Thermal damage
- (5) Evaluation of system fit and coat/trouser overlap
- (6) Loss of seam integrity and broken or missing stitches
- (7)\* Loss of material physical integrity [e.g., ultraviolet (UV) or chemical degradation] as evidenced by discoloration, significant changes in material texture, loss of material strength, loss of liner material, and shifting of liner material
- (8) Loss of wristlet elasticity, stretching, runs, cuts, or burn holes
- (9)\* Reflective trim integrity, attachment to garment, reflectivity, or damage
- (10)\* Label integrity and legibility
- (11) Hook and loop functionality

- (12) Liner attachment systems
- (13) Closure system functionality
- (14) Accessories for compliance with 4.2.3
- (15) Correct assembly and size compatibility of shell, liner, and DRD

**6.3.5.2** Hood elements shall be inspected for the following:

- (1) Soiling
- (2) Contamination
- (3) Physical damage, including, but not limited to, the following:
  - (a) Rips, tears, and cuts
  - (b) Thermal damage (such as charring, burn holes, melting, or discoloration of any layer)
- (4) Damage to or separation of any material as described by the manufacturer
- (5)\* Damage to the particulate-blocking layer, where present, as specified in Section 12.1 or Section 12.2
- (6) Shrinkage
- (7) Loss of material elasticity or stretching out of shape
- (8) Loss of seam integrity or broken or missing stitches
- (9) Loss of face-opening adjustment
- (10)\* Label integrity and legibility

**6.3.5.3** Helmet elements shall be inspected for the following:

- (1) Soiling
- (2) Contamination
- (3) Physical damage to the shell such as the following:
  - (a) Cracks, dents, and abrasions
  - (b) Thermal damage to the shell (such as bubbling, soft spots, warping, or discoloration)
- (4) Physical damage to the ear flaps such as the following:
  - (a) Rips, tears, and cuts
  - (b) Thermal damage (such as charring, burn holes, melting, or discoloration of any layer)
- (5) Damaged or missing components of the suspension and retention systems
- (6) Functionality of suspension and retention systems
- (7) Damaged or missing components of the faceshield/goggle system, including discoloration or scratches to the faceshield/goggle lens limiting visibility
- (8) Functionality of faceshield/goggle system
- (9) Damage to the impact cap
- (10) Damaged or missing reflective trim
- (11) Accessories for compliance with 4.2.3
- (12) Loss of seam integrity and broken or missing stitches
- (13)\* Label integrity and legibility

**6.3.5.4** Glove elements shall be inspected for the following:

- (1) Soiling
- (2) Contamination
- (3)\* Physical damage such as the following:
  - (a) Rips, tears, and cuts
  - (b) Thermal damage (such as charring, burn holes, melting, or discoloration of any layer)
  - (c) Inverted glove liner
  - (d) Loss of seam integrity or broken or missing stitches
- (4) Shrinkage
- (5) Loss of flexibility
- (6) Loss of elasticity and shape in wristlets
- (7) Accessories for compliance with 4.2.3
- (8)\* Label integrity and legibility

**6.3.5.5** Footwear elements shall be inspected for the following:

- (1) Soiling
- (2) Contamination
- (3) Physical damage such as the following:
  - (a) Cuts, tears, punctures, cracking, or splitting
  - (b) Thermal damage (such as charring, burn holes, melting, or discoloration of any layer)
  - (c) Exposed or deformed steel toe, steel midsole, or shank
  - (d) Loss of seam integrity, delamination, or broken or missing stitches
- (4) Loss of water resistance
- (5) Closure system component damage and functionality
- (6)\* Excessive tread wear
- (7) Condition of lining such as the following:
  - (a) Tears
  - (b) Excessive wear
  - (c) Separation from outer layer
- (8) Heel counter failure
- (9) Accessories for compliance with 4.2.3
- (10)\* Label integrity and legibility

**6.3.5.6** Interface components shall be inspected for the following:

- (1) Soiling
- (2) Contamination
- (3) Physical damage
- (4) Loss or reduction of properties that allow component to continue as effective interface, such as loss of shape or inability to remain attached to the respective element(s), if attachment is required
- (5) Loss of seam integrity and broken or missing stitches

**6.3.5.7** DRD components shall be inspected for the following:

- (1) Installation in garment
- (2) Soiling
- (3) Contamination
- (4) Physical damage such as the following:
  - (a) Cuts, tears, punctures, cracking, or splitting
  - (b) Thermal damage (such as charring, burn holes, melting, or discoloration)
  - (c) Loss of seam integrity and broken or missing stitches
- (5)\* Label integrity and legibility

**6.3.6 Additional Advanced Inspection Criteria for Proximity Fire Fighting Protective Ensembles and Ensemble Elements.****6.3.6.1** Proximity fire fighting garment elements shall be inspected for the following:

- (1) Loss of radiant reflectivity
- (2) Loss of radiant reflective coating(s)
- (3) Delamination as evidenced by separation or peeling of the outer shell

**6.3.6.2** Proximity fire fighting helmet overcover components shall be inspected for the following:

- (1) Loss of radiant reflectivity
- (2) Loss of radiant reflective coating(s)
- (3) Damaged or missing reflective trim, if applicable
- (4) Helmet attachment system for damage and functionality
- (5) Delamination as evidenced by separation or peeling of the outer shell

**6.3.6.3** Proximity fire fighting shroud components shall be inspected for the following:

- (1) Loss of radiant reflectivity
- (2) Loss of radiant reflective coating(s)
- (3) Helmet attachment system, if applicable, for damage and functionality
- (4) Distortion of face opening resulting in gaps around the faceshield
- (5) Delamination as evidenced by separation or peeling of the outer shell

**6.3.6.4** Proximity fire fighting helmet elements shall be inspected for the following:

- (1) Loss of faceshield radiant reflectivity
- (2) Loss of shell radiant reflectivity, if applicable

**6.3.6.5** Proximity fire fighting glove elements shall be inspected for the following:

- (1) Loss of radiant reflectivity
- (2) Loss of radiant reflective coating(s)
- (3) Delamination as evidenced by separation or peeling of the outer shell

**6.3.6.6** Proximity fire fighting footwear shall be inspected for the following:

- (1) Loss of radiant reflectivity
- (2) Loss of radiant reflective coating(s)

**6.3.7 Additional Advanced Inspection Criteria for Ensembles with Optional Liquid and Particulate Contaminant Protection.****6.3.7.1\*** Liquid and particulate contaminant protective ensembles shall be inspected according to the manufacturer's instructions.**6.3.7.2** Complete liner inspection of all garment elements shall be conducted at a minimum after 2 years in service and annually thereafter or whenever advance inspections indicate that a problem might exist.**6.3.7.3** Liquid and particulate contaminant protective ensembles shall be inspected for loss of integrity, including, but not limited to, the following:

- (1) Loss of interface functionality
- (2) Excessive material or component shrinkage or stretching

**6.4 Complete Liner Inspection.****6.4.1** Complete liner inspection of all garment elements shall be performed by the garment manufacturer, a manufacturer-trained organization, a verified organization, or a verified ISP.**6.4.2** The member(s) of the organization who has received training in the complete liner inspection of the garment element shall be responsible for performing, managing, or coordinating the complete liner inspection or the complete liner inspection process.**6.4.2.1** The garment element manufacturer or a verified ISP and the organization shall determine the level of training required to perform complete liner inspections. The garment element manufacturer or verified ISP shall provide written verification of training.**6.4.2.1.1** If the organization is a verified organization, it shall be permitted to determine the level of training necessary to

perform the complete liner inspection without any further written verification.

**6.4.3** Complete liner inspection of all garment elements shall be conducted as part of the advanced inspection annually and whenever a routine inspection determines potential damage. The liner system shall be opened to expose all layers for inspection and testing.

**6.4.4** The findings of the complete liner inspection shall be documented.

**6.4.5** The complete liner inspection shall include, as a minimum, the inspection specified in 6.4.5.1 through 6.4.5.3.

**6.4.5.1\*** The moisture barrier and the thermal barrier shall be inspected for the following:

- (1) Physical damage to all layers and sides of each layer such as the following:
  - (a) Rips, tears, cuts, and abrasions
  - (b) Thermal damage (charring, burn holes, melting, or discoloration of any layer)
- (2) Loss of seam integrity, broken or missing stitches, and loose or missing moisture barrier seam tape
- (3) Material physical integrity; UV or chemical degradation as evidenced by discoloration, significant changes in material texture, loss of material strength, loss of liner material, or shifting of liner material
- (4) Delamination as evidenced by separation of film from substrate fabric, flaking, or powdering

**6.4.5.2** The moisture barrier shall be tested using the hydrostatic test to evaluate the water penetration barrier, as specified in Section 12.3, and shall show no leakage.

**6.4.5.3** The result of each water penetration barrier evaluation shall be recorded.

## Chapter 7 Cleaning and Decontamination

### 7.1\* General.

**Δ 7.1.1 Approach for Handling Ensemble Elements After Incident Response.** Organizations shall provide a means for cleaning ensemble elements.

**N 7.1.1.1\*** Cleaning capabilities shall be permitted to be conducted in-house by a manufacturer-trained organization, a verified organization, a verified cleaner, a manufacturer verified in cleaning, a verified ISP, or any combination thereof.

**N 7.1.1.2** Organizations shall use the decision tool provided in Figure 7.1.1.2(a) and Figure 7.1.1.2(b) to assist in determining the appropriate cleaning procedures to follow as specified in Sections 7.2 through 7.5.

**N 7.1.1.3\*** With the exception of CBRN contamination or other forms of contamination, where further contact with specific hazardous contaminants requires immediate removal of ensembles or ensemble elements, preliminary exposure reduction procedures shall be applied as specified in Section 7.2 prior to any cleaning.

**N 7.1.1.4** Organizations shall develop standard operating procedures for field use that reflect the specific decision-making process described in this section.

**N 7.1.1.5** Soiled or contaminated elements shall not be brought into the home, washed in home laundries, or washed in public laundries.

**N 7.1.1.6\*** Commercial dry cleaning, particularly those processes using perchloroethylene or related solvents, shall not be used as a means of cleaning ensembles and ensemble elements unless approved by the ensemble or ensemble element manufacturer.

**Δ 7.1.2\* Approach for Deciding the Handling, Cleaning, and Disposition of Ensemble Elements.**

**N 7.1.2.1** Ensembles and ensemble elements shall be evaluated by the wearer or a designated individual within the organization for application of preliminary exposure reduction, cleaning, disinfection, or sanitization after each use based on the guidance provided in Figure 7.1.1.2(a).

**Δ 7.1.2.2** Ensembles and ensemble elements contaminated by CBRN terrorism agents shall be immediately retired after confirmed exposure and shall not be subjected to cleaning.

**N 7.1.2.2.1** CBRN terrorism agent-contaminated ensembles and ensemble elements shall be doffed as soon as possible, bagged, and disposed of as hazardous waste in accordance with federal, state, and local regulations.

**N 7.1.2.3** Ensembles and ensemble elements that were used in a hazardous materials incident shall be subject to preliminary exposure reduction as specified in Section 7.2 and then assessed by qualified members of the hazardous materials team or other qualified experts with knowledge about the specific exposures that took place.

**N 7.1.2.3.1** The information gained from the hazardous materials team or other experts shall be used to determine whether cleaning is possible.

**N 7.1.2.3.1.1** If it is determined that cleaning is possible, an appropriate form of specialized cleaning shall be applied to the affected ensembles and ensemble elements to remove contamination or reduce it to a safe level.

**N 7.1.2.3.1.2** If it is determined that cleaning is not possible or that the ensemble or ensemble elements have been damaged beyond repair, the affected ensembles and ensemble elements shall be condemned, retired, and not subjected to cleaning.

**N 7.1.2.3.2** Ensembles and ensemble elements that were contaminated during a hazardous materials incident and cannot be cleaned shall be disposed of as hazardous waste in accordance with federal, state, and local regulations.

**7.1.2.4** Ensembles and ensemble elements that are known or suspected to be contaminated with bulk chemicals, asbestos, or other designated hazardous substances, body fluids, or other microbial contamination, or products of combustion from a structural or other fire shall be subject to preliminary exposure reduction as specified in Section 7.2.

**N 7.1.2.5** Ensembles and ensemble elements that are soiled but not contaminated shall be subject to preliminary exposure reduction as specified in Section 7.2.

**N 7.1.2.5.1** If the ensemble and ensemble elements have been subjected to soiling, the ensemble and ensemble elements shall be subjected to advanced cleaning as needed and as specified in Section 7.3.



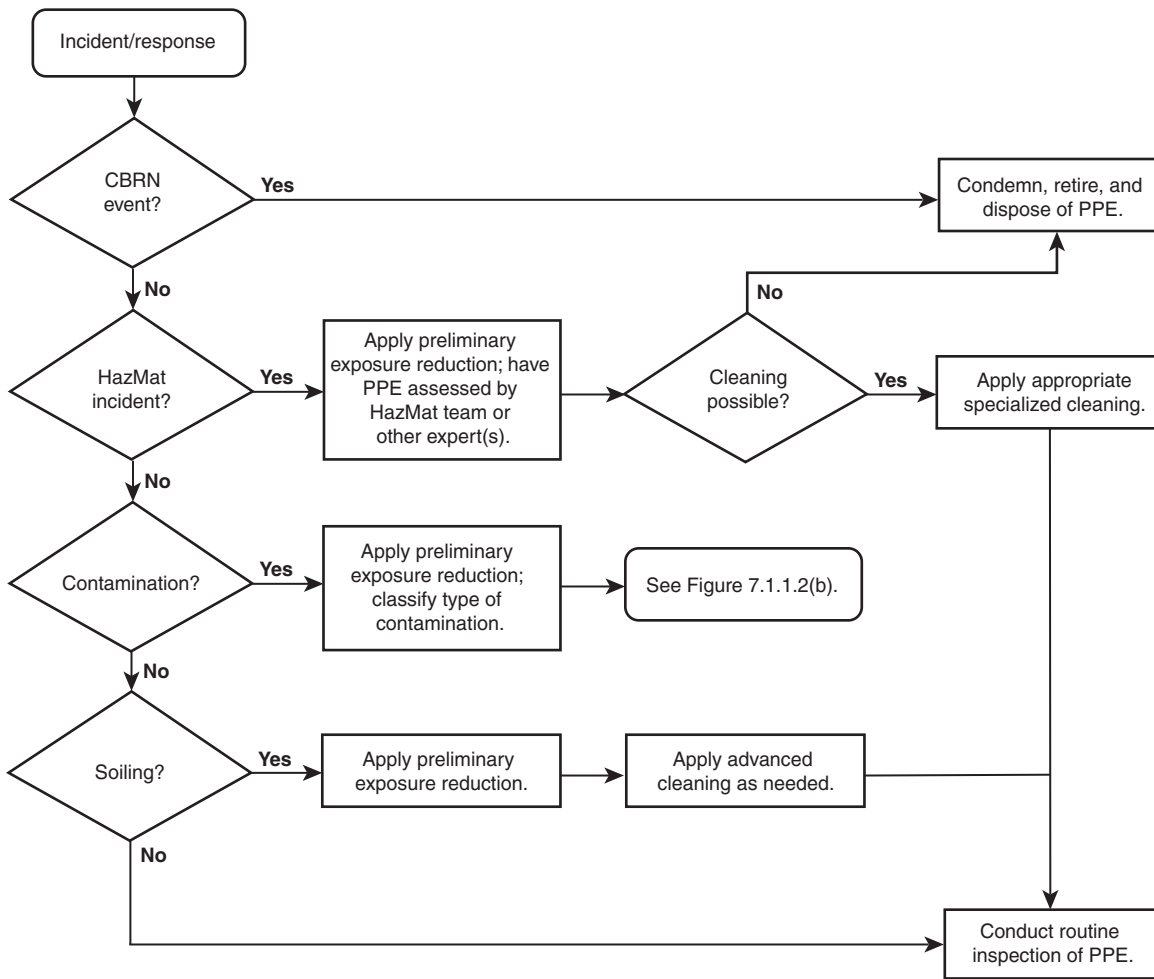

Note: Contaminants shown in relative hierarchy of exposure risk. Multiple forms of contamination might apply. Clean according to highest risk.

**N** FIGURE 7.1.1.2(a) Approach for Deciding Handling, Cleaning, and Disposition of Ensemble Elements.

**N 7.1.2.5.2** If the ensemble and ensemble elements are not soiled and do not require advanced cleaning, the ensemble and ensemble elements shall be subjected to routine inspection as specified in Section 6.2.

**N 7.1.3\* Approach for Addressing Specific Types of Contamination.** Where ensembles and ensemble elements have been suspected or found to have contamination from bulk chemicals, asbestos, or other designated hazardous substances, body fluids, or other forms of microbial contamination, or products of combustion products from a structural or other fire, the organization shall apply the steps shown in Figure 7.1.1.2(b).

**Δ 7.1.3.1 General Decontamination Actions.**

**N 7.1.3.1.1** Where the form of contamination cannot be identified, contaminated ensembles and ensemble elements shall be subject to preliminary exposure reduction, isolated, and removed from service until the suspected contaminant(s) is identified and the elements can receive advanced or specialized cleaning, as necessary, to remove it.

**N 7.1.3.1.2** Where multiple forms of contamination are present, the actions for the handling and cleaning and disposition of ensemble and ensemble elements shall be according to the contamination posing the highest risk.

**N 7.1.3.2 Bulk Chemical Decontamination Actions.**

**N 7.1.3.2.1** Ensembles and ensemble elements that are known or suspected to be contaminated with bulk chemicals shall be subject to preliminary exposure reduction as specified in Section 7.2 and isolated, tagged, and bagged at the incident scene.

**N 7.1.3.2.2** The type of bulk chemical contamination shall be assessed by the organization's hazardous materials team or other qualified experts to determine if cleaning or decontamination of the ensembles and ensemble elements is possible.

**Δ 7.1.3.2.2.1** Where the contaminant and its source have been identified, the organization shall consult the supplier of the contaminant, the manufacturer of the ensemble and ensemble elements, a verified cleaner, or a verified ISP for an appropriate decontamination agent and process.

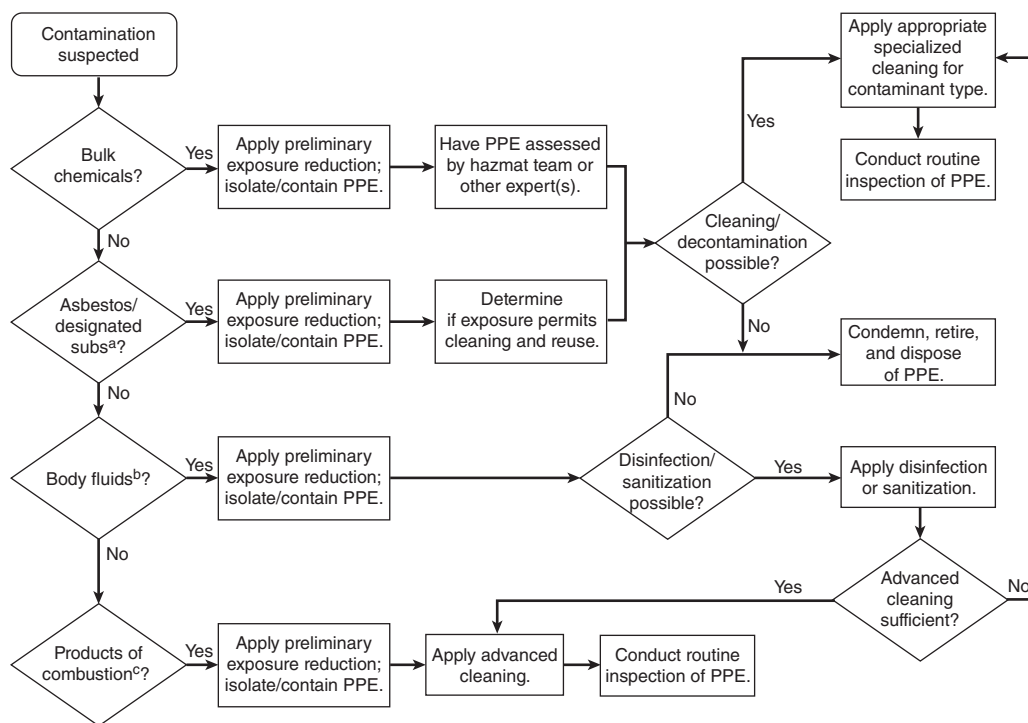

Notes:

<sup>a</sup>And other designated substances

<sup>b</sup>Includes other microbial contamination

<sup>c</sup>Includes any significant structural fire exposure

**N** FIGURE 7.1.1.2(b) Approach for Addressing Specific Types of Contamination.

**N** 7.1.3.2.2.2 Based on the assessment of the type of contamination conditions, if cleaning or decontamination is not possible, then the affected ensemble and ensemble elements shall be condemned, retired, and disposed of as hazardous waste in accordance with federal, state, and local regulations.

**N** 7.1.3.2.2.3 Based on the assessment of the contamination conditions, if cleaning or decontamination is considered possible, then the affected ensemble and ensemble elements shall be subjected to specialized cleaning as specified in Section 7.5.

**N** 7.1.3.3 Asbestos and Other Designated Hazardous Substance Decontamination Actions.

**N** 7.1.3.3.1 Ensembles and ensemble elements that are known or suspected to be contaminated with asbestos or other designated highly hazardous substances shall be subject to preliminary exposure reduction as specified in Section 7.2 and isolated, tagged, and bagged at the incident scene.

**N** 7.1.3.3.2 The organization's hazardous materials team or other qualified experts shall determine if cleaning or decontamination of the ensemble and ensemble elements is possible.

**N** 7.1.3.3.2.1 Based on the assessment of the contamination conditions, if cleaning or decontamination is not possible, then the affected ensemble and ensemble elements shall be condemned, retired, and disposed of as hazardous waste in accordance with federal, state, and local regulations.

**N** 7.1.3.3.2.2 Based on the assessment of the contamination conditions, if cleaning or decontamination is considered possible,

then the affected ensemble and ensemble elements shall be subjected to specialized cleaning as specified in Section 7.5.

**N** 7.1.3.4 Body Fluid and Other Microbial Contamination Disinfection and Sanitization Actions.

**N** 7.1.3.4.1\* Ensembles and ensemble elements that are known or suspected to be contaminated with body fluids or other forms of microbial contaminants shall be subject to preliminary exposure reduction as specified in Section 7.2 and isolated, tagged, and bagged at the incident scene.

**N** 7.1.3.4.2 The organization or qualified experts shall determine if disinfection or sanitization and cleaning of the ensemble and ensemble elements is possible.

**N** 7.1.3.4.2.1 Based on the assessment of the contamination conditions, if disinfection or sanitization and cleaning is not possible, then the affected ensemble and ensemble elements shall be condemned, retired, and disposed of as biological waste in accordance with federal, state, and local regulations.

**N** 7.1.3.4.2.2 Based on the assessment of the contaminant, if disinfection or sanitization is considered possible, then the affected ensemble and ensemble elements shall be subjected to disinfection or sanitization procedures, followed by either advanced cleaning or specialized cleaning procedures as specified in Sections 7.4 and 7.3 or 7.5, respectively.

**N** 7.1.3.4.2.3\* The organization or qualified experts shall determine whether advanced cleaning or specialized cleaning shall be applied in conjunction with disinfection or sanitization. Specialized cleaning shall be permitted to be used in lieu of

advanced cleaning, in conjunction with disinfection or sanitization, for those contamination circumstances where advanced cleaning is not considered sufficient to provide appropriate cleaning conditions in conjunction with the procedures used for disinfection or sanitization.

#### **N 7.1.3.5 Products of Combustion Cleaning Actions.**

**N 7.1.3.5.1\*** Ensembles and ensemble elements that have been exposed to products of combustion shall be subject to preliminary exposure reduction as specified in Section 7.2 and isolated, tagged, and bagged at the incident scene.

**N 7.1.3.5.2\*** Following preliminary exposure reduction, ensembles and ensemble elements shall be subject to advanced cleaning as specified in Section 7.3 as soon as possible following the event.

**N 7.1.3.6 Special Provisions for Ensemble Elements.** Where elements of an ensemble are connected, the following procedures shall be used:

- (1) When one element is connected to another element and they are not permanently attached to each other, individual elements shall be disassembled from each other prior to beginning the cleaning process of elements and all disassembled elements shall undergo a separate cleaning process.
- (2) When one element is connected to another element and they are not permanently attached to each other and are subsequently disassembled from each other prior to beginning the cleaning process, they shall be reassembled prior to any return to service in a like manner to their original manufactured state.

#### **7.2\* Preliminary Exposure Reduction.**

##### **N 7.2.1 General.**

**N 7.2.1.1\*** Organizations shall include preliminary exposure reduction as part of their overall program for the care and maintenance of structural fire-fighting ensembles and ensemble elements and proximity fire-fighting ensembles and ensemble elements.

**7.2.1.2\*** Organizations shall be responsible for implementing preliminary exposure reduction procedures on scene for ensemble and ensemble elements.

##### **7.2.2\* Preliminary Exposure Reduction Procedures.**

**7.2.2.1\*** End users shall carry out preliminary exposure reduction immediately after exiting the emergency scene at any incident where their protective ensemble or ensemble elements could have become soiled or contaminated.

**7.2.2.2\*** Upon exiting the emergency scene, the end user shall remain on self-contained breathing apparatus (SCBA) air.

**7.2.2.3** If returning to the emergency scene after an air cylinder change, any dry debris shall be brushed off the helmet, facepiece, and SCBA prior to changing out the cylinder.

**N 7.2.2.4\*** If the end user is completing their time on scene, dry or wet mitigation techniques shall be conducted prior to the removal of any ensemble or ensemble elements.

**N 7.2.2.4.1\*** The dry mitigation techniques shall be performed by brushing debris from the exterior of ensembles and ensemble elements with a soft bristle brush prior to removal.

**7.2.2.4.2\*** The wet mitigation techniques shall be performed by gently rinsing the exterior of ensembles and ensemble elements using low-pressure and low-volume flow water.

**N 7.2.2.4.2.1** A mild detergent shall be permitted to be used to aid in the wet mitigation technique, followed by gentle rinsing.

**N 7.2.2.4.2.2** Heavy scrubbing or spraying with high-velocity water jets such as a power washer shall not be used.

**N 7.2.2.4.3** If used in combination, dry mitigation shall precede wet mitigation.

**N 7.2.2.5\*** Following dry or wet mitigation, ensemble or ensemble elements shall be isolated and bagged. Where possible, ensemble or ensemble elements, even when bagged, shall not be transported in the passenger areas of apparatus or personal vehicles.

**N 7.2.2.6** Following preliminary exposure reduction, the ensemble or ensemble element(s) shall be subjected to the appropriate cleaning procedures specified in Section 7.1.

**N 7.2.3 Additional Requirements for Preliminary Exposure Reduction of Hood Interface Components.** Following each structural fire or emergency service use, hood interface components shall be subjected to preliminary exposure reduction and advanced cleaning as specified in Section 7.3.

**N 7.2.4\* Additional Requirements for Preliminary Exposure Reduction of Eye and Face Protection Components.** After each use, eye and face protection components that are provided as part of the helmet or as separate devices shall be subjected to preliminary exposure reduction and wiped off and cleaned.

**7.2.5 Additional Requirements for Preliminary Exposure Reduction of Proximity Fire-Fighting Ensembles and Ensemble Elements.** During preliminary exposure reduction, the use of a brush or any other abrasive cleaning devices on radiant reflective outer shells and other components of proximity fire-fighting protective ensembles and ensemble elements shall not be permitted.

##### **7.3 Advanced Cleaning.**

**7.3.1** Advanced cleaning shall be performed by an element manufacturer verified in cleaning, a verified cleaner, a manufacturer-trained organization, a verified organization, or a verified ISP.

**N 7.3.1.1** In the absence of a method to verify effectiveness of cleaning, manufacturers of certified ensembles and ensemble elements shall be permitted to provide advanced cleaning.

**7.3.1.2** The member(s) of the organization who has received training in the advanced cleaning of the ensembles or ensemble elements shall be responsible for performing, managing, or coordinating advanced cleaning or the advanced cleaning process.

**N 7.3.1.3\*** Training shall meet the requirements specified in 4.2.4.5.

**N 7.3.2** If the organization is a verified organization, it shall be permitted to determine the level of training that is needed for carrying out the advanced cleaning.

**7.3.3\*** Ensembles and ensemble elements that are soiled or contaminated shall receive advanced cleaning.

- N 7.3.3.1** Ensembles or ensemble elements that have been exposed to blood or other body fluids shall be subjected to sanitization or disinfection prior to advanced cleaning as specified in Section 7.4.
- N 7.3.3.2\*** Advanced cleaning shall be permitted in lieu of sanitization or disinfection if the procedures for advanced cleaning have proven effective for sanitization or disinfection of the ensemble or ensemble elements.
- N 7.3.3.3\*** Ensembles or ensemble elements that have been exposed to bulk chemicals, unusual biological contaminants, asbestos, or other substances of a highly hazardous or unusual nature shall be subjected to specialized cleaning as specified in Section 7.5 in lieu of advanced cleaning.
- N 7.3.3.3.1** Advanced cleaning shall only be applied for the contaminants described in 7.3.3.3 if known to be effective for removing the specific contaminants.
- 7.3.4\*** Where not subjected to prior advanced cleaning, ensembles and ensemble elements that are issued and used shall receive advanced cleaning at least every six months, resulting in a minimum of two advanced cleanings in a 12-month period, with one of these advanced cleanings occurring at the time of annual advanced inspection.
- 7.3.5\*** Where the use of machine cleaning is specified for ensembles and ensemble elements, advanced cleaning shall be conducted using a washer/extractor with the following characteristics unless specifically prohibited:
- (1) The washer/extractor shall be programmable to permit multiple formulations for adjustments of detergent application, water temperature, water level, cycle type/function, and cycle time.
  - (2)\* The washer/extractor shall not have a g-force that exceeds 100 G or shall have the capability of drum revolutions per minute (RPM) adjustment such that the g-force can be adjusted to not exceed 100 G for all washed ensembles and ensemble elements.
- N 7.3.6\*** Top-loading washing machines with or without a center post agitator shall not be used for advanced cleaning of ensembles and ensemble elements or components.
- N 7.3.6.1\*** Before using any cleaning device other than a washer/extractor, the element manufacturer, verified cleaner, or verified ISP shall be contacted for instructions on how to best clean the ensemble(s) or ensemble element(s) using the respective cleaning device.
- N 7.3.7** Detergents and other cleaning or pretreatment chemicals used in the advanced cleaning of ensembles and ensemble elements shall be appropriate for the respective ensemble or ensemble element.
- N 7.3.7.1** Chlorine bleach, chlorinated solvents, or solvents shall not be used without the ensemble or ensemble element manufacturer's or verified ISP's approval. (*See A. 7.3.6.1.*)
- N 7.3.7.2\*** For advanced cleaning, a mild detergent with a pH range of not less than 6.0 pH and not greater than 10.5 pH as indicated on the product safety data sheet (SDS) or original product container shall be used.
- N 7.3.7.3\*** Selected detergents and cleaning agents shall not knowingly cause significant long-term degradation of ensemble or ensemble element performance when applied at the expected cleaning frequency over the service life of the ensemble or ensemble element.
- N 7.3.7.4\*** Any testing used in the evaluation of the cleaning effectiveness of specific ensembles or ensemble elements subjected to advanced cleaning procedures shall account for both contaminated and cleaned sample analyses.
- N 7.3.8\*** Universal precautions shall be applied in the washing of all soiled or contaminated ensembles or ensemble elements.
- Δ 7.3.9** Where machine washing with a washer/extractor is specified, the following procedures shall be used:
- (1)\* The washer/extractor shall not be overloaded or under loaded.
  - (2)\* Heavily soiled or spotted areas shall be pretreated.
  - (3) All closures, including pocket closures, hooks and loops, snaps, zippers, and hooks and dees, shall be fastened.
  - (4)\* Water temperature shall not exceed 40°C (105°F).
  - (5)\* The specific formulation for the washer/extractor shall include a series of steps for filling the wash basket, adding detergent, performing multiple rinses, and including separate extractions between wash and rinse steps.
  - (6) The element shall be inspected and rewashed if necessary.
- Δ 7.3.10\* Drying Procedures.**
- N 7.3.10.1** Ensembles and ensemble elements shall be dried using one of the following procedures in:
- (1)\* Air drying, as follows:
    - (a)\* Place ensembles or ensemble elements in an area with good ventilation.
    - (b)\* Do not dry ensembles or ensemble elements in direct or indirect sunlight, under fluorescent light, or under UV light.
    - (c) Do not allow the area used for drying to exceed 40°C (105°F).
  - (2)\* A drying cabinet, as follows:
    - (a) Place ensembles or ensemble elements in the drying cabinet to allow good air circulation between each ensemble or ensemble element.
    - (b) Use a specific drying time and drying temperature to provide sufficient drying of the ensembles or ensemble elements.
    - (c) Do not allow the area used for drying to exceed 40°C (105°F).
  - (3)\* Machine drying, as follows:
    - (a) The recommended capacity of the machine shall not be exceeded.
    - (b) All closures, including pocket closures, hooks and loops, snaps, zippers, and hooks and dees, shall be fastened. A hook that is not part of a closure shall be covered with a piece of loop.
    - (c)\* A "no heat" or "air dry" option shall be used, if available.
    - (d)\* In the absence of a "no heat" or "air dry" option, the basket temperature shall not exceed 40°C (105°F).
    - (e)\* The use of a heat cycle shall be discontinued prior to the removal of all moisture from the ensembles or ensemble elements.
    - (f)\* The remainder of the drying process shall be accomplished by a "no heat" machine setting or

removal of the ensembles or ensemble elements from the machine dryer to air dry.

**N** 7.3.10.2 Ensembles or ensemble elements that are not completely dry shall not be returned to service.

### 7.3.11 Additional Requirements for Advanced Cleaning of Garment Elements.

**N** 7.3.11.1 Garment elements shall be subjected to advanced cleaning using a washer/extractor with an appropriate formulation.

**N** 7.3.11.1.1 A top loading washing machine or utility sink shall not be used for advanced cleaning.

**N** 7.3.11.1.2 Separate washer/extractor formulations shall be permitted for garment outer shells and liners. [See A. 7.3.9(5).]

**N** 7.3.11.2\* Where the shells and liners of protective garment elements are separable, those components shall be cleaned only with similar components.

**N** 7.3.11.2.1 Heavily soiled outer shells shall be permitted to be pretreated by soaking in an appropriate solution of detergent and water.

**N** 7.3.11.2.2 Separable liner systems shall be oriented such that the moisture barrier is on the inside for advanced cleaning for both laundering and drying.

**N** 7.3.11.2.3 Separate washer/extractor formulations shall be permitted for washing garment shells versus garment liners.

**7.3.11.3** If the coat element has a drag rescue device (DRD) and the DRD is removable, the DRD shall be permitted to be laundered with the coat shell or coat liner.

**N** 7.3.11.3.1 Where recommended as being washed separately, removable DRDs shall be placed in a separate mesh bag for advanced cleaning.

**N** 7.3.11.3.2 DRDs placed in mesh bags shall be permitted to be washed with garment outer shells.

**N** 7.3.11.4 If the garment includes fall protection components, and the fall protection components are removable, the fall protection components shall be removed prior to advanced cleaning.

**N** 7.3.11.4.1 If the fall protection components also require cleaning, the fall protection components shall be cleaned separately according to the manufacturer's instructions.

### 7.3.12 Additional Requirements for Advanced Cleaning of Helmet Elements.

**7.3.12.1\*** Detachable or separate components, such as ear covers, suspensions covers, and goggles, shall be removed from the helmet and shall be washed and dried separately.

**N** 7.3.12.2\* Detachable components that are textile based shall either be separately hand washed or washed in a washer/extractor with other components such as garments or hoods as specified in 7.3.11.

**7.3.12.3** Helmets shall not be machine cleaned or dried using equipment that produces mechanical action by tumbling or agitation.

**N** 7.3.12.4\* Unless otherwise specified, helmets shall be hand washed in a utility sink using the following procedures:

- (1) The individual washing the helmet shall observe universal precautions and put on a pair of examination gloves, an apron and protective sleeves or coveralls, and a pair of safety glasses or goggles.
- (2)\* The utility sink shall be filled with warm water at temperature no warmer than 40°C (105°F) and a mild detergent having a pH of not less than 6.0 or more than 10.5 at the detergent manufacturer's recommended ratio of detergent to water.
- (3) The individual shall use a soft bristle brush to reach between components and scrub both the exterior and interior of the helmet.
- (4) The helmet shall be thoroughly rinsed following washing.
- (5) Following rinsing, the helmet shall be air dried. It shall be permitted to use a soft towel to aid in drying the helmet after cleaning.

**N** 7.3.12.5 Attached faceshields shall be hand washed with a soft cloth.

### Δ 7.3.13 Additional Requirements for Advanced Cleaning of Glove Elements.

**N** 7.3.13.1\* Gloves shall not be machine dried using equipment that produces mechanical action by tumbling or agitation.

**N** 7.3.13.2 Unless otherwise specified, gloves shall be hand washed in a utility sink or other container of sufficient size using the following procedures:

- (1) The individual washing the gloves shall observe universal precautions and shall put on a pair of examination gloves, an apron and protective sleeves or coveralls, and a pair of safety glasses or goggles.
- (2)\* The utility sink shall be filled with warm water at temperature no warmer than 40°C (105°F) and a mild detergent having a pH of not less than 6.0 or more than 10.5 at the detergent manufacturer's recommended ratio of detergent to water.
- (3) The individual shall then don the fire-fighting gloves over the examination gloves and shall briskly rub the gloves together, ensuring the cleaning of all surfaces. A soft bristle brush shall be permitted to scrub the exterior of the gloves.
- (4)\* The individual shall then remove the fire-fighting gloves and refill the utility sink with clean water.
- (5) The interior and exterior of the gloves shall be thoroughly rinsed with clean water.
- (6) Gloves shall not be wrung out, but instead slightly squeezed to remove excess water.
- (7)\* Gloves shall be dried using ambient or slightly raised temperatures no warmer than 40°C (105°F). Equipment that provides airflow into the interiors of gloves shall be permitted to aid the faster drying of gloves.

### Δ 7.3.14 Additional Requirements for Advanced Cleaning of Footwear Elements.

**N** 7.3.14.1\* Footwear shall not be machine cleaned or dried using equipment that produces mechanical action by tumbling or agitation.

**N** 7.3.14.2 Unless otherwise specified, footwear shall be hand washed in a utility sink or other container of sufficient size using the following procedures:

- (1) The individual washing the footwear shall observe universal precautions and put on a pair of examination gloves,

an apron and protective sleeves or coveralls, and a pair of safety glasses or goggles.

- (2)\* The utility sink shall be filled with warm water at a temperature no warmer than 40°C (105°F) and a mild detergent having a pH of not less than 6.0 or more than 10.5 at the detergent manufacturer's recommended ratio of detergent to water.
- (3)\* The individual shall first scrub the interior of the footwear with a soft bristle brush.
- (4) The individual shall then scrub the exterior of the footwear with a soft bristle brush, ensuring the cleaning of all exterior surfaces.
- (5) The interior and exterior of the footwear shall be thoroughly rinsed with clean water.
- (6)\* In the absence of specialized drying equipment, the footwear shall be suspended upside down to dry, with attention that water runoff does not create a slip hazard.
- (7) If specified by the manufacturer, a sealant, conditioning, or polish shall be applied to leather footwear after the footwear has completely dried.

#### ▲ 7.3.15 Additional Requirements for Advanced Cleaning of Hood Elements.

■ 7.3.15.1 Hoods shall be permitted to be hand or machine washed, independently or with garment liners, as allowed by the hood manufacturer. The hood manufacturer's instructions shall be consulted for further cleaning instructions.

■ 7.3.15.2 If hoods are hand washed in a utility sink or other suitable container, hoods shall not be wrung out to dry, but instead slightly squeezed to remove excess water after rinsing.

■ 7.3.15.3 Hoods shall be permitted to be air dried or machine dried.

■ 7.3.15.4 Special care shall be applied to the advanced cleaning of particulate-blocking hoods. Advanced cleaning of particulate-blocking hoods shall be in accordance with procedures provided by the manufacturer.

■ 7.3.15.5 Where hoods are subjected to hand cleaning and unless otherwise specified, hoods shall be hand washed in a utility sink or other container of sufficient size using the following procedures:

- (1) The individual washing the hood shall observe universal precautions and put on a pair of examination gloves, an apron and protective sleeves or coveralls, and a pair of safety glasses or goggles.
- (2) The utility sink shall be filled with warm water at temperature no warmer than 40°C (105°F) and a mild detergent having a pH of not less than 6.0 or more than 10.5 at the detergent manufacturer's recommended ratio of detergent to water.
- (3) After allowing the hood to presoak for a period of at least 10 minutes, the individual shall lightly rub the hood material together, starting with the exterior and then turning the hood inside out and similarly rubbing the material against itself. A soft wash cloth shall be permitted for washing the hoods.
- (4) Stretching or wringing the hood out shall be avoided during hand washing.
- (5) The hood shall be thoroughly rinsed following washing.
- (6) Following rinsing, if using air drying, the hood shall be air dried by laying on a drying rack or other surface that helps promote draining of water from the hood.

#### 7.3.16 Additional Requirements for Advanced Cleaning of Proximity Fire-Fighting Ensembles and Ensemble Elements.

■ 7.3.16.1 Except as noted in 7.3.16.2, proximity fire-fighting protective ensembles and ensemble elements shall be cleaned in accordance with the same requirements as non-proximity fire-fighting protective ensembles and ensemble elements.

▲ 7.3.16.2 Outer shell and other radiant reflective components of proximity fire-fighting protective ensembles and ensemble elements shall be cleaned in accordance with the following:

- (1) They shall not be cleaned with a brush or other abrasive cleaning devices.
- (2) They shall not be machine washed or dried.
- (3) They shall be wiped with a moist soft cloth or sponge.
- (4) They shall be hung without any folding of the shell and air dried without any mechanical action.

● 7.3.17 Additional Requirements for Advanced Cleaning of Ensembles Certified to the Optional Liquid and Particulate Contaminant Protection Requirements of NFPA 1971. The manufacturer shall be consulted to determine if any special handling procedures or the removal of interface components or other components must be undertaken prior to advanced cleaning.

#### ● 7.4 Disinfection or Sanitization and Biological Decontamination.

■ 7.4.1 Processes for disinfecting or sanitizing, cleaning, and decontaminating protective ensembles and ensemble elements that have been contaminated with body fluids and other potentially infectious materials shall be performed by a manufacturer verified in cleaning, a verified cleaner, a manufacturer-trained organization, a verified organization, or a verified ISP.

■ 7.4.1.1 In the absence of a method to verify effectiveness of cleaning, manufacturers of certified protective ensembles and ensemble elements shall be permitted to perform disinfection or sanitization and biological decontamination.

■ 7.4.2\* Organizations and other facilities that engage in disinfection or sanitization and biological decontamination of protective ensembles and ensemble elements contaminated with body fluids and other potentially infectious materials shall comply with the applicable regulations in 29 CFR 1910.1030, "Bloodborne Pathogens."

■ 7.4.3\* Protective ensembles and ensemble elements that are contaminated with body fluids and other potentially infectious materials shall be subject to either disinfection or sanitization.

■ 7.4.3.1 If not already part of an advanced cleaning process, disinfection or sanitization shall be followed by advanced cleaning depending on the type of disinfection or sanitization, the cleaning agents and processes that are available, and the type and composition of the ensemble or ensemble element.

■ 7.4.3.2\* Disinfectants and sanitizers shall be registered with the U.S. Environmental Protection Agency (EPA) for efficacy for hard surfaces or fabrics and textiles, whichever is applicable.

■ 7.4.3.2.1\* Where disinfection or sanitization is required for specific microbial contamination as determined by the organization or qualified experts, those disinfectants and sanitizers registered with the EPA for the specific form of microbial contamination shall be used.

- N 7.4.3.3\*** Where disinfectants and sanitizers are used, they shall not degrade the performance properties of the protective ensemble or ensemble elements.
- N 7.4.3.4** Disinfectants and sanitizers shall be used in accordance with the instructions provided by the supplier.
- N 7.4.3.5\*** It shall be permitted to include disinfection or sanitization as part of the advanced cleaning process only when its effectiveness has been demonstrated as providing the disinfection or sanitization required for the specific ensemble or ensemble element.
- N 7.4.3.6\*** In cases where the area of contamination is limited and clearly visible, spot sanitization or disinfection followed by spot cleaning shall be permitted for the sanitization or disinfection of the affected contaminated area of the ensemble or ensemble element.
- N 7.4.3.7\*** Specialized cleaning shall be permitted to be used in lieu of advanced cleaning when ensembles and ensemble elements are disinfected or sanitized.
- N 7.4.4 Additional Requirements for Sanitization and Cleaning of Garment Elements.**
- N 7.4.4.1\*** Garment elements shall be subjected to a minimum of sanitization.
- N 7.4.4.2** The sanitizer or process used for the sanitization of the garment element shall meet the verification testing requirements in 11.3.7.5.
- N 7.4.4.3\*** Handling of garment elements shall be kept to a minimum prior to sanitization.
- N 7.4.4.4** Where specific components such as the DRD or fall protection devices are provided as part of garment elements, these items shall only be removed from the garment if their presence will interfere with the sanitization process.
- N 7.4.4.4.1\*** Both garment element outer shells and liners shall be subject to sanitization, including garments that have been contaminated with pathogenic bioaerosols.
- N 7.4.4.5** Advanced cleaning procedures that are used in conjunction with or that follow sanitization for removal of soils associated with body fluids or other infectious materials shall meet the applicable garment requirements specified in Section 7.3.
- N 7.4.4.6** Advanced cleaning or specialized cleaning shall be performed after sanitization.
- N 7.4.4.6.1\*** Advanced cleaning shall be permitted in lieu of sanitization or disinfection if the procedures for advanced cleaning have proven effective for sanitization or disinfection of the ensemble or ensemble elements.
- N 7.4.5 Additional Requirements for Disinfection or Sanitization and Cleaning of Helmet Elements.**
- N 7.4.5.1\*** Detachable or separate components shall be removed from the helmet and shall be sanitized or disinfected separately.
- N 7.4.5.2** Detachable components that are textile based shall be sanitized as specified in 7.4.4 for garment elements.
- N 7.4.5.3\*** Hard surface components of the helmet shall be subject to disinfection using an appropriate disinfection process.
- N 7.4.5.4** Subsequent advanced cleaning of helmets following their disinfection or sanitization shall meet the requirements specified in 7.3.12.
- N 7.4.6 Additional Requirements for Sanitization and Cleaning of Glove Elements.**
- N 7.4.6.1\*** Sanitizers or processes for sanitization of gloves shall be selected as appropriate for the materials used in the construction of the glove.
- N 7.4.6.2** Subsequent advanced cleaning of gloves following their sanitization shall meet the requirements specified in 7.3.13.
- N 7.4.7 Additional Requirements for Sanitization and Cleaning of Footwear Elements.**
- N 7.4.7.1\*** Sanitizers or processes for sanitization of footwear shall be selected as appropriate for the materials used in the construction of the footwear.
- N 7.4.7.2** Subsequent advanced cleaning of footwear following their sanitization shall meet the requirements specified in 7.3.14.
- N 7.4.8 Additional Requirements for Sanitization and Cleaning of Hood Elements.**
- N 7.4.8.1\*** Hoods shall be sanitized as specified in 7.4.4 for garment elements.
- N 7.4.8.2** Subsequent advanced cleaning of hoods following their sanitization shall meet the requirements specified in 7.3.15.
- N 7.4.9 Additional Requirements for Sanitization and Cleaning of Proximity Fire-Fighting Ensembles and Ensemble Elements.**
- N 7.4.9.1** Any sanitizer or process used for sanitization shall not degrade the radiant reflective outer shell or other radiant reflective elements of the ensemble or ensemble elements.
- N 7.4.9.2** Any additional cleaning of proximity fire-fighting ensembles and ensemble elements shall meet the requirements specified in 7.3.16.
- N 7.4.9.3** Nonreflective portions of the ensemble or ensemble elements shall be treated as specified in 7.4.4.
- N 7.4.10 Additional Requirements for Sanitization and Cleaning of Ensembles and Ensemble Elements Certified to the Optional Liquid and Particulate Contaminant Protection Requirements of NFPA 1971.** The manufacturer shall be consulted to determine if any special handling procedures exist for the sanitization or disinfection and subsequent cleaning of the elements of the protective ensemble or ensemble element.
- N 7.5 Specialized Cleaning.**
- N 7.5.1** Specialized cleaning of protective ensembles and ensemble elements shall be performed by a manufacturer verified in cleaning, a manufacturer-trained organization, a verified organization, a verified cleaner, or a verified ISP.
- N 7.5.1.1** In the absence of a method to verify effectiveness of cleaning for specific types of soils or contaminants, manufac-

turers of certified ensembles or ensemble elements shall be permitted to perform specialized cleaning.

**N 7.5.2\*** Organizations shall employ specialized cleaning when the ensemble or ensemble elements cannot be adequately cleaned with advanced cleaning.

**N 7.5.2.1** Organizations shall apply disinfection or sanitization in accordance with Section 7.4 with specialized cleaning for the removal of body fluids or other infectious materials that cannot be removed using disinfection or sanitization with advanced cleaning.

**N 7.5.3\*** Organizations shall designate any specific substances or contaminants that warrant specialized cleaning and shall determine specific approaches for decontamination for these substances, if warranted.

**N 7.5.4** Organizations shall rely on expertise from hazardous materials teams, infection control specialists, verified independent service providers, or other individuals knowledgeable for the type of contaminant and how it can be removed from protective clothing and equipment.

**N 7.5.4.1** The expertise described in 7.5.4 shall be relied upon for determining whether the type of contamination can be effectively removed and for determining the procedures to be used for the removal of the specific contaminant(s), if applicable.

**N 7.5.4.2** Where deemed appropriate for the purpose of specialized cleaning of garment elements, a maximum washer/extractor water temperature shall be permitted to be 60°C (140°F) for those ensembles or ensemble elements that are specified for advanced cleaning using a washer/extractor. [See A.7.3.9(4).]

**N 7.5.4.3** Where it is determined that the contaminant(s) cannot be sufficiently removed, the ensembles or ensemble elements shall be condemned and disposed of in accordance with federal, state, and local regulations for the handling and disposal of hazardous materials.

**N 7.5.4.4\*** Where it is determined that the contaminant(s) can be sufficiently removed, specific procedures shall be conducted for cleaning, treating, or decontaminating the contaminated ensembles or ensemble elements based on one of the following:

- (1) Evidence is provided from a documented source that the applied procedures have shown effectiveness in the past under similar exposure circumstances and contamination conditions.
- (2) Testing of the contaminated clothing items is performed that provides detailed results showing the absence of any residual contamination or showing levels of contaminants that are deemed to be safe.

**N 7.5.4.5\*** Any testing procedures that are used for assessing residual levels of contamination shall be specific to the contaminants of concern and shall be performed by a laboratory that is accredited for the specific types of analysis carried out on the ensembles or ensemble elements.

**N 7.5.4.6** When specialized cleaning is applied for the cleaning of ensembles or ensemble elements involving highly hazardous contaminants, consideration should be given to the disposition of the effluent from the cleaning process and whether disposal

into the local sewer system is acceptable according to federal, state, and local regulations.

## Chapter 8 Repair

### 8.1 Requirements for All Ensembles and Ensemble Elements.

**Δ 8.1.1** All repairs shall be performed by the original manufacturer, a verified ISP, or a member of the organization who has received training.

**8.1.1.1** Training shall be provided by an element manufacturer of the same element type or by a verified ISP in the repair of ensembles or ensemble elements.

**8.1.1.2** Requirements for garment element repair shall be specified in Sections 8.2 through 8.4.

**8.1.2** The member(s) of the organization who has received training in the repair of the ensembles or ensemble elements shall be responsible for performing or managing repairs.

**8.1.3** Ensembles or ensemble elements shall be subjected to advanced cleaning, when necessary, before any repair work is undertaken. Ensembles contaminated by CBRN terrorism agents shall be immediately retired after CBRN exposure is confirmed and shall not be reused.

**Δ 8.1.4\*** All repairs and alterations to the ensemble or ensemble element shall be done in a manner and using like materials and components that are compliant with NFPA 1971.

**8.1.5** Due to the different methods of construction, the ensemble or ensemble element manufacturer shall be contacted if the organization or verified ISP is unsure of whether a repair can be accomplished without adversely affecting the integrity of the ensemble or ensemble element.

**8.1.6** Replacement interface components shall be installed in a manner consistent with the ensemble or ensemble element manufacturer's method of construction.

### 8.2 Requirements for Both Basic and Advanced Garment Element Repair.

**8.2.1** All repairs and alterations shall be performed in the same manner and using like materials as the garment element manufacturer, including, but not limited to, fabric, thread type, seam construction, hardware, and hardware backing, unless approved by the garment element manufacturer.

**8.2.2** Repairs shall be made to all components and to all layers of the composite that have been damaged or that have been affected by the repair.

**Δ 8.2.3** Repairs of minor tears, char marks, ember burns, and abraded areas shall be limited to those where the damaged area can be covered by a maximum 160 cm<sup>2</sup> (25 in.<sup>2</sup>) patch of the same material that is compliant with NFPA 1971. For any tears, char marks, ember burns, and abraded areas that require a patch larger than 160 cm<sup>2</sup> (25 in.<sup>2</sup>), the manufacturer or the verified ISP, in conjunction with the organization, shall be consulted.

**8.2.3.1** The finished edges of the patch shall extend at least 25 mm (1 in.) in all directions beyond the damaged area.

**8.2.3.2** To prevent fraying, the patch shall have no raw edges.



△ 8.2.3.3 Where tears, holes, or abrasions are being repaired, the damaged areas shall be mended using flame-resistant (FR) thread that is compliant with NFPA 1971 to prevent further damage prior to application of the patch.

△ 8.2.3.4 Where moisture barrier tears, holes, or abrasions are being repaired, the repair tape shall be required to extend at least 12.5 mm (½ in.) in all directions beyond the edge of the repaired damage. Where the moisture barrier has a hole or abrasion measuring more than 12.5 mm (½ in.) in diameter in any direction or a tear greater than 75 mm (3 in.) in length, a patch consisting of the same moisture barrier fabric shall be used for repair. Where a moisture barrier manufacturer provides repair tape in various sizes, it shall be permitted to be used for the repair.

8.2.4\* Replacement hardware shall be installed in a manner consistent with the garment element manufacturer's method of construction.

8.2.4.1 When hardware is replaced, the reinforcement backing material shall be reinstalled or, if it is no longer serviceable, the backing material shall be replaced.

8.2.5 If the complexity of the repair is uncertain, the garment element manufacturer shall be consulted.

8.2.6 Replacement visibility markings shall be installed in a manner consistent with the garment element manufacturer's method of construction, unless an alternative method is approved by the garment element manufacturer.

8.2.6.1 Visibility markings being replaced shall be completely removed so that no new visibility marking is sewn over an older sewn visibility marking. New visibility markings shall be permitted to be applied over older visibility markings by alternative methods where approved by the garment manufacturer.

△ 8.2.6.2 No repair or alteration shall result in the reduction of the minimum required visibility marking pattern specified in Section 6.2 of NFPA 1971.

8.2.6.3 Visibility marking patches that do not exceed 75 mm (3 in.) in length shall be permitted. The visibility marking patch shall extend 25 mm (1 in.) beyond the damaged area. A maximum of two visibility marking patches per stripe shall be permitted.

8.2.6.4 Where a repair or alteration necessitates replacing visibility markings, an equal amount of visibility markings shall be installed.

8.2.6.5 Where the complexity of the visibility marking repair is uncertain, the garment element manufacturer shall be consulted.

**8.3 Additional Requirements for Basic Garment Element Repair.** The repairs specified in this section shall be performed by the element manufacturer, the organization, manufacturer-trained organizations, verified organizations, or verified ISPs. Basic repairs shall be limited to the following:

- (1) Patching of minor tears, char marks, and ember burns to a separable outer shell
- (2) Repairing of skipped, broken, and missing stitches to a separable outer shell
- (3) Replacement of missing hardware, excluding positive closure systems to a separable outer shell
- (4) Reclosing of the liner of a garment after inspection

#### **8.4 Additional Requirements for Advanced Garment Element Repair.**

8.4.1\* The repairs specified in this section shall be conducted only by the element manufacturer, a verified organization, or a verified ISP meeting the requirements as specified in Chapter 11, Verification.

8.4.2 Repairs to the garment outer shell shall be performed consistent with the garment element manufacturer's methods. The garment element manufacturer shall be contacted if the organization is unsure of the complexity of the repair.

8.4.3\* All repairs to the garment moisture barrier shall be performed consistent with the moisture barrier manufacturer's methods. The original garment element manufacturer shall be contacted if the organization is unsure as to whether an area to be repaired contains a moisture barrier.

8.4.4\* Repairs to garment thermal liners shall be permitted provided the repair does not result in any stitching through the moisture barrier.

8.4.5\* Due to labeling requirements, as well as the complexity and specialized equipment needed to replace entire garment element component layers (e.g., the outer shell, moisture barrier, or thermal liner), only the garment element manufacturer or the garment element manufacturer's designated verified ISP shall replace entire garment component layers.

8.4.6 Restitching of more than 25 mm continuous (1 in. continuous) of a Major A seam shall require consulting the garment element manufacturer and shall be conducted in a manner consistent with the garment element manufacturer's methods.

8.4.7 Repairs to Major B seams in the moisture barrier shall require consulting the garment element manufacturer and shall be conducted in a manner consistent with the barrier manufacturer's recommendations.

8.4.7.1 Repairs to Major B seams in the thermal liner that do not affect any moisture barrier material shall be permitted. Restitching of more than 25 mm continuous (1 in. continuous) of any Major B seams shall require consulting the garment element manufacturer and shall be conducted in a manner consistent with the garment element manufacturer's methods.

8.4.8\* All repaired stress areas shall be reinforced in a manner consistent with the garment element manufacturer's methods.

8.4.9 If replacing trim necessitates sewing into a Major A seam, trim replacement shall be conducted in a manner consistent with the garment element manufacturer's methods.

8.4.10\* Replacement zippers shall be installed in a manner consistent with the garment element manufacturer's method of construction. If the complexity of the repair is uncertain, the garment element manufacturer shall be consulted.

8.4.11\* Replacement hook-and-loop fastener tape shall be installed in a manner consistent with the garment element manufacturer's method of construction. If the complexity of the repair is uncertain, the garment element manufacturer shall be consulted.

8.4.12\* Replacement reinforcement materials shall be installed in a manner consistent with the garment element manufacturer's method of construction.

## 8.5 Helmet Element Repair.

**8.5.1** In addition to the requirements in Section 8.1, all repairs to helmet components other than as specified herein shall be performed in accordance with the helmet element manufacturer's instructions.

**8.5.2\*** Where there is an indication of a crack, dent, abrasion, bubbling, soft spot, discoloration, or warping in the helmet shell, the helmet element manufacturer shall be contacted to determine serviceability.

**8.5.3** Small surface nicks shall be repaired in accordance with the helmet element manufacturer's instructions.

**8.5.4** Small scratches on the helmet shell shall be permitted to be removed by using mildly abrasive compounds recommended by the helmet element manufacturer.

**8.5.5** Helmet faceshield and goggle components that become cracked or badly scratched shall be replaced.

**8.6 Glove Element Repair.** In addition to the requirements in Section 8.1, all repairs to glove components shall be performed in accordance with the glove element manufacturer's instructions.

## 8.7 Footwear Element Repair.

**8.7.1** In addition to the requirements in Section 8.1, all repairs to footwear components shall be performed in accordance with the footwear manufacturer's instructions.

**8.7.2** Other than for the replacement of bootlaces and zipper assemblies, the footwear manufacturer shall be contacted to determine feasibility of the repair.

**8.7.3** All replacement bootlaces and zippers shall be provided by the footwear element manufacturer.

**8.8 Structural Fire Fighting Hood and Proximity Fire Fighting Helmet Overcover and Proximity Fire Fighting Shroud Repair.** In addition to the requirements in Section 8.1, all repairs to hoods, helmet covers, and proximity shrouds shall be performed in accordance with the element manufacturers' instructions. Repairs of these interface components containing a particulate blocking layer shall not be undertaken unless authorized by the manufacturer.

**8.9 Additional Requirements for Structural Fire Fighting Ensembles and Proximity Fire Fighting Ensembles with Optional Liquid and Particulate Contaminant Protection.** In addition to the requirements in Section 8.1, all repairs to ensembles with optional liquid and particulate contaminant protection shall be referred to the ensemble manufacturer.

## Chapter 9 Storage

### 9.1\* All Ensembles and Ensemble Elements.

**9.1.1\*** Ensembles or ensemble elements not in use shall not be exposed to lighting that emits UV rays, including, but not limited to, fluorescent lighting, direct sunlight, and indirect sunlight.

**9.1.2\*** Ensembles and ensemble elements shall be clean and dry before storage.

**9.1.3** Ensemble and ensemble elements shall not be stored in airtight containers unless they are new and unissued.

**9.1.4\*** Ensembles and ensemble elements shall not be stored at temperatures below  $-32^{\circ}\text{C}$  ( $-25^{\circ}\text{F}$ ) or above  $82^{\circ}\text{C}$  ( $180^{\circ}\text{F}$ ).

**9.1.5** Ensembles and ensemble elements shall not be stored or transported in compartments or trunks with sharp objects, tools, or other equipment that could damage the ensembles or ensemble elements. Where ensembles or ensemble elements must be transported or stored in such environments, the ensemble or element(s) shall be placed in a protective case or bag to prevent damage.

**9.1.6\*** Issued ensembles and ensemble elements shall not be allowed in living quarters. Contaminated or soiled clothing shall not be transported in the cab of fire department apparatus when not being worn for operational duties unless placed in an airtight protective case or bag to prevent cross contamination. If placed in a protective case or bag, the ensemble(s) or ensemble element(s) shall be removed from such environments as soon as possible following transport. Wet ensembles or ensemble elements shall not be stored in a protective case or bag used for transport.

**9.1.7\*** Ensembles and ensemble elements shall not be stored in contact with contaminants such as, but not limited to, oils, solvents, acids, or alkalis.

**9.1.8** Proximity fire fighting protective coat and trouser elements shall be stored by hanging to limit the damage caused by creasing and shall not be stored folded.

**N 9.1.9** Eye and face protection shall be readily accessible to the user and, when not in use, shall be stored in such a manner so as to prevent at least the following:

- (1) Thermal damage
- (2) Mechanical damage
- (3) Hazardous materials contamination

**9.1.10** Ensemble and ensemble element storage areas shall be clean, dry, and well ventilated.

## Chapter 10 Retirement, Disposition, and Special Incident Procedure

### 10.1 Retirement.

**10.1.1\*** The organization shall develop specific criteria for removal of structural fire fighting ensembles and ensemble elements and proximity fire fighting ensembles and ensemble elements from service, which includes, but is not limited to, issues that are specific to the ensembles or ensemble elements being used by the organization, the manufacturer's instructions, and the experience of the organization.

**10.1.2\*** Structural fire fighting ensembles and ensemble elements shall be retired in accordance with 10.2.1 or 10.2.2, no more than 10 years from the date the ensembles or ensemble elements were manufactured.

**10.1.3** Proximity fire fighting ensembles and ensemble elements shall be retired in accordance with 10.2.1 or 10.2.2, no more than 10 years from the date the ensembles or ensemble elements were manufactured.

**10.1.3.1\*** In all cases, the radiant reflective outer shell of the garment element shall be replaced no more than 5 years from the date the ensembles or ensemble elements were manufactured.

**Δ 10.1.4\*** Structural fire fighting ensembles and ensemble elements and proximity fire fighting ensembles and ensemble elements that are worn or damaged to the extent that the organization deems it not possible or cost effective to repair shall be retired in accordance with 10.2.1.

**10.1.5\*** Structural fire fighting ensembles and ensemble elements and proximity fire fighting ensembles and ensemble elements that were not in compliance with the edition of the applicable NFPA standard that was current when the ensembles and ensemble elements were manufactured shall be retired in accordance with 10.2.1.

**10.1.6** Structural fire fighting ensembles and ensemble elements and proximity fire fighting ensembles and ensemble elements that are contaminated to the extent that the organization deems it not possible or cost effective to **clean** them shall be retired in accordance with 10.2.1.

**10.1.7** Structural fire fighting ensembles and ensemble elements and proximity fire fighting ensembles and ensemble elements that are contaminated by CBRN terrorism agents shall be immediately retired as specified in 10.2.1 after confirmed exposure and shall not be reused.

**10.1.8\*** Structural fire fighting ensembles and ensemble elements and proximity fire fighting ensembles and ensemble elements that are no longer of use to the organization for emergency operations service but are not contaminated, defective, or damaged shall be retired in accordance with 10.2.1 or 10.2.2.

## 10.2 Disposition of Retired Elements.

**10.2.1** Retired structural fire fighting ensembles and ensemble elements and proximity fire fighting ensembles and ensemble elements shall be destroyed or disposed of in a manner ensuring that they will not be used in any fire fighting or emergency activities, including live fire training.

**10.2.2** Retired structural fire fighting ensembles and ensemble elements and proximity fire fighting ensembles and ensemble elements **determined to be no longer of use in accordance with 10.1.8** shall be permitted to be used as follows:

- (1) For training that does not involve live fire, provided the ensembles and ensemble elements are appropriately marked as being for non-live fire training only
- (2) As determined by the organization

## 10.3 Special Incident Procedure.

**10.3.1\*** The organization shall have procedures for the handling and custody of structural fire fighting ensembles and ensemble elements and proximity fire fighting ensembles and ensemble elements that were worn by fire fighters who were victims at incidents where serious injuries or fatalities to the fire fighters occurred.

**10.3.2** In the absence of any other prevailing rules of evidence, the organization's procedures shall include at least the following:

- (1) Provisions shall be made for the immediate removal from service and preservation of all structural fire fighting ensembles and ensemble elements and proximity fire fighting ensembles and ensemble elements utilized by the injured or deceased fire fighter.

- (2) Custody of such ensembles and ensemble elements shall be maintained at a secure location with controlled, documented access.
- (3) All such structural fire fighting ensembles and ensemble elements and proximity fire fighting ensembles and ensemble elements shall be nondestructively tagged and stored only in paper or cardboard containers to prevent further degradation or damage. Plastic or airtight containers shall not be used.
- (4) Examination of the structural fire fighting ensembles and ensemble elements and proximity fire fighting ensembles and ensemble elements shall be made by qualified members of the organization or by outside experts to determine the condition thereof.

**10.3.3** The organization shall determine a specific period of time for retaining custody of structural fire fighting ensembles and ensemble elements and proximity fire fighting ensembles and ensemble elements.

## Chapter 11 Verification

### 11.1 General.

**11.1.1** In order for an organization, **ISP, cleaner, or manufacturer** to be verified, it shall meet the requirements of this chapter.

**11.1.1.1\*** Verification of the organization or ISP shall include advanced inspection, advanced cleaning, **sanitization**, and advanced repairs of garment elements only as specified in **Table 11.1.1.1**.

**N 11.1.1.1.1** Cleaning and sanitization verification of the organization or ISP shall not apply to helmet elements, glove elements, footwear elements, hood elements, or optional liquid and particulate contaminant protective ensembles.

**N 11.1.1.1.2** Cleaning and sanitization verification of cleaners and manufacturers shall not apply to helmet elements, glove elements, footwear elements, hood elements, or optional liquid and particulate contaminant protective ensembles.

**11.1.1.2** An organization or **manufacturer** shall be permitted to be verified for **any combination of advanced cleaning, sanitization, advanced inspection, and repairs**.

**N 11.1.1.2.1** An ISP shall be verified for advanced cleaning, sanitization, advanced inspection, and repairs but shall not be permitted to be verified for advanced cleaning and advanced inspection only.

**N 11.1.1.2.2** A cleaner shall only be verified for advanced cleaning and sanitization of garment elements.

**N 11.1.1.2.3** Manufacturers verified in cleaning shall be verified per the verified cleaner requirements in accordance with Table 11.1.1.1 and shall be permitted to perform advanced inspection and advanced repair.

**11.1.1.3** Where an organization or ISP is verified for conducting repairs, the organization or ISP shall also be verified for advanced cleaning, **sanitization**, and advanced inspection.

**11.1.1.4** The verified organization, **verified ISP, manufacturer verified in cleaning, or verified cleaner** shall be listed.

**N 11.1.1.4.1** The listing shall specify the services the listee is verified to conduct.

**N** Table 11.1.1.1 ISP and Organization Verification Designation Criteria

Function/Capability	Verified ISP or Verified Organization	Verified Cleaner
Advanced cleaning	Required	Required
Heavy metals cleaning efficiency	≥50% for each metal	≥50% for each metal
Semivolatile organic compound cleaning efficiency	≥50% average of all compounds	≥50% average of all compounds
Biological sanitization effectiveness — <i>Staphylococcus aureus</i>	3 log reduction or better	3 log reduction or better
Biological sanitization effectiveness — <i>Klebsiella pneumoniae</i>	3 log reduction or better	3 log reduction or better
Advanced inspection	All ensembles and ensemble elements of structural and proximity fire fighter protective clothing	Not allowed
Advanced repair	All ensembles and ensemble elements capable of being repaired for structural and proximity fire fighter protective clothing that they have been specifically verified to repair	No repairs allowed
Advanced repairs for moisture barriers	ISPs have a choice of which moisture barriers to verify	Not allowed
Verification testing timing	Every two years, or when processes change	Every two years, or when processes change
Verification facility quality review and inspection	Every six months	Every six months

**N** 11.1.1.4.2 Repair categories shall be garment outer shell repairs, garment moisture barrier repairs, and garment thermal barrier repairs.

11.1.1.5 Where the certification listing includes the moisture barrier repair category, the listing shall include the moisture barrier manufacturer and trade name designation, and the repair tape manufacturer and trade name or part number.

**Δ** 11.1.2 All verification of the organization, ISP, manufacturer verified in cleaning, or verified cleaner shall be performed by a certification organization that meets at least the requirements specified in Section 11.2 and that is accredited for personal protective equipment (PPE) in accordance with ISO/IEC 17065, *Conformity assessment — Requirements for bodies certifying products, processes and services*. The accreditation shall be issued by an accreditation body operating in accordance with ISO 17011, *Conformity assessment — General requirements for accreditation bodies accrediting conformity assessment bodies*.

11.1.3 The verified organization, verified ISP, manufacturer verified in cleaning, or verified cleaner shall not use the NFPA name or the name or identification of this standard, NFPA 1851, in any statements about its services unless the services are verified as compliant to this standard.

11.1.3.1\* No provider of the services covered by this standard shall claim to be an ISP, a verified ISP, a verified organization, a manufacturer verified in cleaning, or a verified cleaner unless they comply with all of the requirements in this standard and are third-party verified in accordance with the requirements of this chapter.

11.1.4 The certification organization shall not issue any new verifications to the 2014 edition of NFPA 1851 on or after the NFPA effective date for the 2020 edition.

11.1.5 Organizations, ISPs, or manufacturers verified to the 2014 edition of NFPA 1851 shall undergo verification to the 2020 edition of NFPA 1851 within 18 months of the NFPA effective date for the 2020 edition.

## 11.2 Verification Program.

**11.2.1\*** The certification organization shall not be owned or controlled by the organization or the ISP being verified.

**11.2.2** The certification organization shall be primarily engaged in certification work and shall not have a monetary interest in the organization's, ISP's, or manufacturer's ultimate profitability.

**Δ 11.2.3** The certification organization shall be accredited for PPE in accordance with ISO/IEC 17065, *Conformity assessment – Requirements for bodies certifying products, processes and services*. The accreditation shall be issued by an accreditation body operating in accordance with ISO 17011, *Conformity assessment — General requirements for accreditation bodies accrediting conformity assessment bodies*.

**11.2.4** The certification organization shall refuse to verify services to this standard that do not comply with all applicable requirements of this standard.

**11.2.5\*** The contractual provisions between the certification organization and the organization, the ISP, or the manufacturer shall specify that verification is contingent on compliance with all applicable requirements of this standard.

**11.2.6** The certification organization shall not offer or confer any conditional or temporary verification.

**Δ 11.2.7\*** The certification organization shall have laboratory facilities and equipment available for conducting proper tests to determine compliance.

**11.2.8** The certification organization's laboratory facilities shall have a program in place and functioning for calibration of all instruments, and procedures shall be in use to ensure proper control of all testing.

**11.2.9** The certification organization's laboratory facilities shall follow good practice regarding the use of laboratory manuals, form data sheets, documented calibration and calibration routines, performance verification, proficiency testing, and staff qualification and training programs.

**11.2.10** The certification organization shall require the organization or the ISP to establish and maintain a quality management program that meets the requirements of Section 11.4.

**11.2.11** The certification organization and the organization, ISP, or manufacturer verified in cleaning shall evaluate any changes affecting function of the compliant services to determine continued certification to this standard.

**Δ 11.2.12\*** The certification organization shall have a follow-up inspection program of the facilities of the compliant services with at least one random and unannounced visit in accordance with Table 11.1.1.1.

**11.2.13** The certification organization shall be permitted to conduct additional specific testing to verify continued compliance.

**11.2.14** The certification organization's operating procedures shall provide a mechanism for the organization or the ISP to appeal decisions. The procedures shall include the presentation of information from both sides of a controversy to a designated appeals panel.

**11.2.15** The certification organization shall be in a position to use legal means to protect the integrity of its name. The name shall be registered and legally defended.

**N 11.2.16\*** The certification organization shall have a procedure for investigating noncompliant verified cleaning or repairs that addresses complaints related to cleaning or repairs performed by verified ISPs or verified organizations that are not in compliance with the requirements of this standard.

**N 11.2.16.1** Where a complaint of noncompliant cleaning or repairs for a verified ISP or verified organization is received by the certification organization, the validity of the report shall be investigated and, if necessary, corrective action shall be taken.

## 11.3 Inspection and Testing.

**11.3.1** For verification of the compliant services, the certification organization shall conduct both inspection and testing as specified in this section.

**11.3.2** All inspections, evaluations, conditioning, and testing for verification of the organization, ISP, verified cleaner, or manufacturer verified in cleaning shall be conducted by a certification organization's testing laboratory that is accredited in accordance with the requirements of ISO 17025, *General requirements for the competence of testing and calibration laboratories*.

**11.3.3** The certification organization's testing laboratory's scope of accreditation to ISO 17025, *General requirements for the competence of testing and calibration laboratories*, shall encompass testing of PPE.

**11.3.4** The accreditation of a certification organization's testing laboratory shall be issued by an accreditation body operating in accordance with ISO 17011, *Conformity assessment — General requirements for accreditation bodies accrediting conformity assessment bodies*.

**11.3.5** A certification organization shall be permitted to utilize conditioning and testing results conducted by an organization or an ISP for verification, provided the organization or the ISP testing laboratory meets the requirements specified in 11.3.5.1 through 11.3.5.5.

**11.3.5.1** Where an organization or an ISP provides conditioning and testing results to the certification organization, the organization's or ISP's testing laboratory shall be accredited in accordance with the requirements of ISO 17025, *General requirements for the competence of testing and calibration laboratories*.

**11.3.5.2** The organization or ISP testing laboratory's scope of accreditation to ISO 17025, *General requirements for the competence of testing and calibration laboratories*, shall encompass testing of PPE.

**11.3.5.3** The accreditation of an organization's or ISP's testing laboratory shall be issued by an accreditation body operating in accordance with ISO 17011, *Conformity assessment — General requirements for accreditation bodies accrediting conformity assessment bodies*.

**11.3.5.4** The certification organization shall also approve the organization's or ISP's testing laboratory.

**11.3.5.5** The certification organization shall determine the level of supervision and witnessing of the conditioning and testing for verification conducted at the organization's or ISP's testing laboratory.

**11.3.6** Sampling levels for testing and inspection shall be established by the certification organization and the organization or the ISP to ensure reasonable and acceptable reliability at a reasonable and acceptable confidence level that repair services are compliant to this standard, unless such sampling levels are specified herein.

**N 11.3.6.1** Where an organization, ISP, or manufacturer operates multiple facilities in different locations, each separate location shall be subject to verification.

**N 11.3.6.2\*** For the purpose of verification of advanced cleaning and sanitization, the certification organization shall review the respective facility to determine the equipment and procedures that, through engineering judgment, will result in the lowest level of cleaning. The equipment and procedures shall be selected and subjected to the verification procedures in 11.3.7.

**Δ 11.3.7\*** For verification of cleaning, the certification organization shall evaluate the effectiveness of the ISP's, cleaner's, manufacturer's, or organization's cleaning processes against the requirements specified in 11.3.7.2 and 11.3.7.3.

**N 11.3.7.1** For verification of the ability to sanitize and clean protective garments, the certification organization shall evaluate the effectiveness of the ISP's, cleaner's, manufacturer's, or organization's sanitization processes against the requirement specified in 11.3.7.4.

**N 11.3.7.2** When tested for removal of selected products of combustion as specified in Section 12.4, the cleaning process shall provide for a 50 percent or greater cleaning efficiency for the average of all surrogate heavy metal contaminants.

**N 11.3.7.3** When tested for removal of selected products of combustion as specified in Section 12.4, the cleaning process shall provide for a 50 percent or greater average cleaning efficiency for the average of all surrogate semi-volatile organic compounds.

**N 11.3.7.4** When tested for the neutralization and sanitization of biological contaminants as specified in Section 12.5, the sanitization process shall provide for at least log<sub>10</sub>3 reduction of challenge microorganisms.

- 11.3.8** For verification of an organization's or an ISP's repair services, the following series of tests shall be required for each repair category for which the organization or the ISP is verified. Testing shall be conducted using new materials as outlined in Table 11.3.8(a) through Table 11.3.8(c). Initial samples submitted by the organization or ISP for verification shall be permitted to be prepared by that organization or ISP.

**11.3.8.1** For repairs to tears in the outer shell, moisture barrier, and thermal barrier, the certification organization shall inspect the tear in the material(s) to be repaired in accordance with Figure 11.3.8.1 and shall witness the repair of the samples to be tested.

**Δ Table 11.3.8(a) Outer Shell Repairs**

Who Makes Repair	Sample	Material	Test or Evaluation
Organization	5 ft felled seam 5 ft overedge seam	Outer shell material(s) utilized by the organization	NFPA 1971 — 7.1.13
	Small tear patch	Patched tear made from the outer shell material utilized by the organization	NFPA 1851 — 8.2.3
ISP	5 ft felled seam 5 ft overedge seam	7.5 osy Nomex IIIa plain weave fabric	NFPA 1971 — 7.1.13
	Small tear patch	Patched tear made from 7.5 osy Nomex IIIa plain weave fabric	NFPA 1851 — 8.2.3

**Δ Table 11.3.8(b) Thermal Liner Repairs**

Who Makes Repair	Sample	Material	Test or Evaluation
Organization	5 ft felled seam 5 ft overedge seam	Thermal liner material(s) utilized by the organization	NFPA 1971 — 7.1.13
	Small tear patch	Patched tear made from the thermal liner material utilized by the organization	NFPA 1851 — 8.2.3
ISP	5 ft felled seam 5 ft overedge seam	Blended filament/spun face cloth quilted to two layers of E89	NFPA 1971 — 7.1.13
	Small tear patch	Patched tear made from blended filament/spun face cloth quilted to two layers of E89	NFPA 1851 — 8.2.3

**Table 11.3.8(c) Moisture Barrier Repairs**

Who Makes Repair	Sample	Material	Test or Evaluation
Organization	5 ft seam	Moisture barrier material(s) utilized by the organization	NFPA 1971 — 7.1.13
	Pinhole repair	Pinhole repair made from the moisture barrier material(s) utilized by the organization	NFPA 1851 — 8.2.3 and NFPA 1851 — Section 12.3 conditioning in NFPA 1971 — 8.1.2
	Tear patch	Patched tear made from the moisture barrier material(s) utilized by the organization	NFPA 1851 — 8.2.3 and NFPA 1851 — Section 12.3 conditioning in NFPA 1971 — 8.1.2
ISP	5 ft seam	All moisture barrier materials repaired by the ISP	NFPA 1971 — 7.1.13
	Pinhole repair	Pinhole repair made from the moisture barrier material(s) utilized by the ISP	NFPA 1851 — 8.2.3 and NFPA 1851 — Section 12.3 conditioning in NFPA 1971 — 8.1.2
	Tear patch	Patched tear made from the moisture barrier materials repaired by the ISP	NFPA 1851 — 8.2.3 and NFPA 1851 — Section 12.3 conditioning in NFPA 1971 — 8.1.2

**11.3.8.2** For moisture barrier pinhole repairs, the certification organization shall inspect the pinholes in the material(s) to be repaired and shall witness the repair of the samples to be tested. The pinholes shall be created in the material(s) by using a size 8 gauge sewing needle to completely puncture the moisture barrier five times in a 25 mm (1 in.) square located in the center of a 305 mm × 305 mm (12 in. × 12 in.) sample. The 1 in. square shall be clearly marked to identify the damaged area.

**11.3.8.2.1** The damaged and repaired samples specified in 11.3.8.1 and 11.3.8.2 shall be prepared for the conditioning specified in Table 11.3.8(c).

**11.3.8.2.2** Samples for conditioning shall be at least 305 mm (12 in.) square and shall consist of a composite constructed using a layer of 3.8 oz/yd<sup>2</sup> ± 0.3 oz/yd<sup>2</sup> aramid needle-punched nonwoven material, quilted to 3.4 oz/yd<sup>2</sup> ± 0.2 oz/yd<sup>2</sup> aramid woven plain weave thermal barrier material, and the repaired moisture barrier layer. The two-layer composite shall be stitched around the entire periphery in the orientation used in a garment.

**11.3.8.2.3** The moisture barrier layer shall be removed from the two-layer composite samples after all conditioning has been completed and shall become the moisture barrier specimen.

**11.3.8.2.4** Testing shall be performed as specified in Section 12.3.

**11.3.8.3** Sample seams shall be prepared and submitted to the certification organization for verification testing by an NFPA 1971-certified manufacturer, verified organization, or verified ISP.

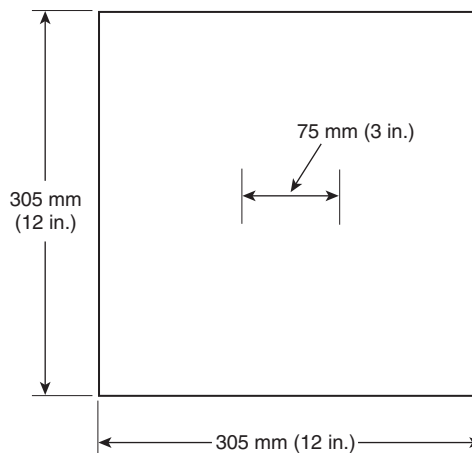
**FIGURE 11.3.8.1 Tear Repairs.**

**11.3.8.3.1** Where a verified organization or verified ISP performs repairs for more than one garment manufacturer, then only one set of seam samples shall be required for verification testing.

**11.3.8.3.2** For moisture barrier seam repairs, the certification organization or ISP shall damage the sample seams by cutting multiple stitches and the seam tape to a distance of 75 mm (3 in.) +12.5 mm/−0.00 mm (+½ in./−0 in.). The certification organization shall inspect the damaged seams and witness the repair of the samples to be tested.

**11.3.8.3.3** For outer shell and thermal barrier seam repairs, the certification organization or ISP shall damage the sample seams by cutting multiple stitches to a distance of 75 mm (3 in.) +12.5 mm/-0.00 mm (+½ in./-0 in.). The certification organization shall inspect the damaged seams and witness the repair of the samples to be tested.

**11.3.8.4** The certification organization shall not allow test samples that have been conditioned and tested for one method to be reconditioned and tested for another test method unless specifically permitted in the test method.

**11.3.9** For verification of an organization’s or ISP’s advanced inspection services, the documentation and measurements specified in Table 11.3.9 shall be evaluated and verified to be compliant by the certification organization.

**11.3.10** For verification of an ISP’s, cleaner’s, manufacturer’s, or organization’s advanced cleaning and sanitization services, the documentation and measurements specified in Table 11.3.10 shall be evaluated and verified to be compliant by the certification organization.

**11.3.11** The organization or the ISP shall maintain all inspection and test data from the certification organization used in the verification of the organization’s or the ISP’s services. The organization or ISP shall provide such data, upon request, to the purchaser or authority having jurisdiction.

**11.4 Organization or ISP Quality Management Program.**

**11.4.1** The organization’s or the ISP’s management shall define and document its policy and objectives for and commitment to quality and shall ensure that this policy is understood, implemented, and maintained at all levels in the organization or the ISP.

**11.4.2** The organization or the ISP shall operate an effective quality system appropriate to the type, range, and volume of work performed.

**11.4.3** The management of the organization or the ISP shall designate a person who, irrespective of other duties, shall have defined authority and responsibility for quality assurance within the organization or ISP. The quality system shall be maintained relevant and current under the responsibility of the same person.

**11.4.3.1** If the verified ISP or verified organization changes the designated person, the verified ISP or verified organization shall notify the certification organization.

**11.4.4** The quality system shall be fully documented. There shall be a Quality Manual, which shall contain at least the following information:

- (1) General information (name, addresses, phone numbers, and legal status)
- (2) Management statement on the organization’s or ISP’s policy on, objectives for, and commitment to quality
- (3) Management statement assigning a responsible person for quality assurance
- (4) Description of the organization’s or ISP’s areas of activity and competence
- (5) Organization chart(s)
- (6) Relevant job descriptions
- (7) Policy statement on qualification and training of personnel
- (8) Procedures for control of documents

- (9) Procedures for internal audits
- (10) Procedures for feedback and corrective action
- (11) Procedures for management review of the quality system
- (12) Distribution list for the Quality Manual
- (13) Work instructions or process manuals
- (14) Procedure for handling returns and complaints

**11.4.5** The organization or ISP shall maintain a system for control of all documentation relating to its activities and shall ensure the following:

- (1) That the current revisions of the appropriate documentation are available at all relevant locations and to all relevant staff
- (2) That all amendments to documents are authorized and processed in a manner that will ensure timely availability at the appropriate location
- (3) That superseded documents are removed from use throughout the organization but that one copy is filed for a determined period
- (4) That other parties, as necessary, are notified of changes

**11.4.6** The organization or the ISP shall carry out a system of planned and documented internal quality audits to verify compliance with the criteria of this standard and the effectiveness of the quality system. The personnel performing the audits shall be suitably qualified and independent from the functions being audited.

**11.4.7** The organization or the ISP shall have documented procedures for dealing with feedback and corrective action whenever discrepancies are detected in the quality system or in the performance of inspections.

**Table 11.3.9 Advanced Inspection Evaluation**

NFPA 1851 Clause to Be Evaluated	Method of Evaluation
6.3.2	Audit or review of organization’s or ISP’s procedures and documentation by certification organization
6.3.4	Audit or review of organization’s or ISP’s procedures and documentation by certification organization
6.3.5.1 (1)–(4) and (6)–(15)	Audit or review of organization’s or ISP’s procedures and documentation by certification organization
6.3.5.7	Audit or review of organization’s or ISP’s procedures and documentation by certification organization
6.3.6.1	Audit or review of organization’s or ISP’s procedures and documentation by certification organization
6.4.2	Audit or review of organization’s or ISP’s procedures and documentation by certification organization
6.4.4	Audit or review of organization’s or ISP’s procedures and documentation by certification organization
6.4.5	Audit or review of organization’s or ISP’s procedures and documentation by certification organization



**Table 11.3.10 Advanced Cleaning Evaluation**

NFPA 1851 Clause to Be Evaluated	Method of Evaluation
7.3.4	Audit or review of organization's or ISP's procedures and documentation by certification organization
7.3.5	Audit or review of organization's or ISP's procedures and documentation by certification organization
7.3.6	Audit or review of organization's or ISP's procedures and documentation by certification organization
7.3.9(1)–(3) and 7.3.9(5)–(6)	Audit or review of organization's or ISP's procedures and documentation by certification organization
7.3.9(4)	Direct measurement or observation by a representative of the certification organization
7.3.11	Audit or review of organization's or ISP's procedures and documentation by certification organization
7.3.16	Audit or review of organization's or ISP's procedures and documentation by certification organization
7.3.10	Audit or review of organization's or ISP's procedures and documentation by certification organization
7.3.10.1(1)(c), 7.3.10.1(2)(c), or 7.3.10.1(3)(d)	Direct measurement or observation by a representative of the certification organization
7.4.4.3	Audit or review of organization's or ISP's procedures and documentation by certification organization
7.4.4.4	Audit or review of organization's or ISP's procedures and documentation by certification organization
7.4.4.6	Audit or review of organization's or ISP's procedures and documentation by certification organization

**11.4.8** The management of the organization or the ISP shall review the quality system at least annually to ensure its continuing suitability and effectiveness. The results of such reviews shall be recorded.

## Chapter 12 Test Procedures

### **N 12.1 Light Evaluation of Hood Particulate-Blocking Layers.**

**N 12.1.1\* Application.** This evaluation method shall apply to particulate-blocking protective hood interface components that are in service.

#### **N 12.1.2 Evaluation Areas.**

**N 12.1.2.1** All portions of the hood interface component that contain a particulate-blocking layer, including seams, shall be evaluated.

**N 12.1.2.2** As a minimum, four areas of the hood shall be evaluated as follows:

- (1) The left side of the hood with the edge of the test area within 62 mm (2.5 in.) of the hood opening [see Figure 12.1.2.2(a)]
- (2) The right side of the hood with the edge of the test area within 62 mm (2.5 in.) of the hood opening [see Figure 12.1.2.2(b)]
- (3) The back of the hood [see Figure 12.1.2.2(c)]
- (4) The middle of any seam area joining two pieces of the particulate-blocking layer

**N 12.1.2.3** Other hood areas subject to 12.1.2.1 shall be permitted to be evaluated.

#### **N 12.1.3 Evaluation Apparatus.**

**N 12.1.3.1\*** An apparatus that consists of a clear head form combined with a bright enough light source to show the changes in density of the liner materials when viewed shall be used. The light source shall be mounted at the center of the head form interior and have a means for turning the light on and off and for its replacement.

**N 12.1.3.2\*** A special fixture shall be permitted to be used that allows portions of the hoods that measure at least 75 mm (3 in.) in diameter to be nondestructively clamped on a holder where a light source is placed below the viewing area.

#### **N 12.1.4 Procedure.**

**N 12.1.4.1** The evaluation procedure shall be conducted indoors in an area that can be darkened so as to provide for optimum viewing of potential damage to the particulate-blocking layer of the hood interface component.

**N 12.1.4.2** The evaluation shall be conducted using the following procedure:

- (1) Don the hood on the head form or position the area of the hood to be examined on the fixture.
- (2) Turn on the light inside the head form or fixture.
- (3) Evaluate areas of the hood that have a particulate-blocking layer in place, including seams.
- (4) For comparison purposes, use a new, unused hood to distinguish the normal appearance of light through an undamaged hood.

**N 12.1.5 Results.** Results shall be determined by evaluating areas where the light is brighter through some areas than others.

**N 12.1.6\* Interpretation.** Brighter areas shall be considered a possible indication of a defect or other damage that compromises the hood's performance.

### **N 12.2 Smoke Evaluation of Hood Particulate-Blocking Layers.**

#### **N 12.2.1 Application.**

**N 12.2.1.1** This evaluation method shall apply to particulate-blocking protective hood interface components that are in service.

**N 12.2.1.2\*** This evaluation method shall be conducted either qualitatively or quantitatively.

#### **N 12.2.2 Evaluation Areas.**

**N 12.2.2.1** All portions of the hood interface component that contain a particulate-blocking layer, including seams within areas having a particulate-blocking layer, shall be evaluated.

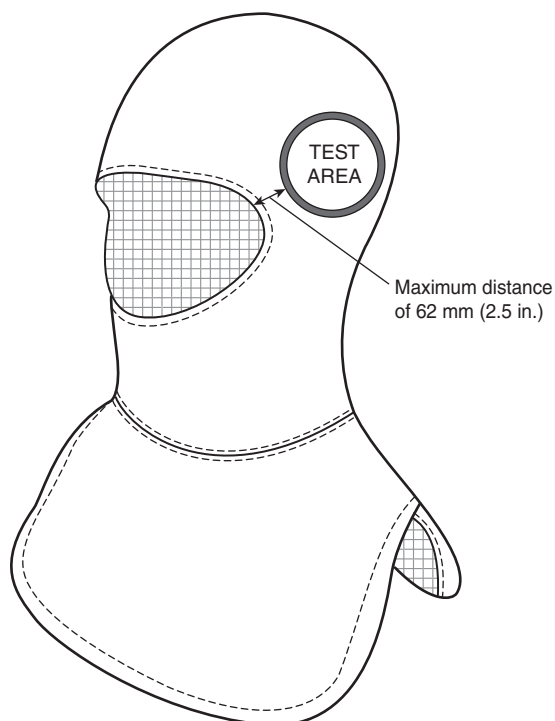

**N** FIGURE 12.1.2.2(a) Minimum Light Evaluation Areas on Left Front Side of Particulate-Blocking Hood.

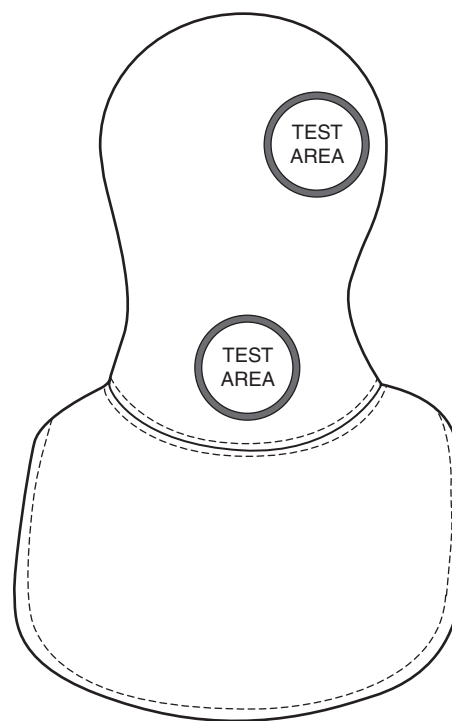

**N** FIGURE 12.1.2.2(c) Minimum Evaluation Areas on Back of Particulate-Blocking Hood.

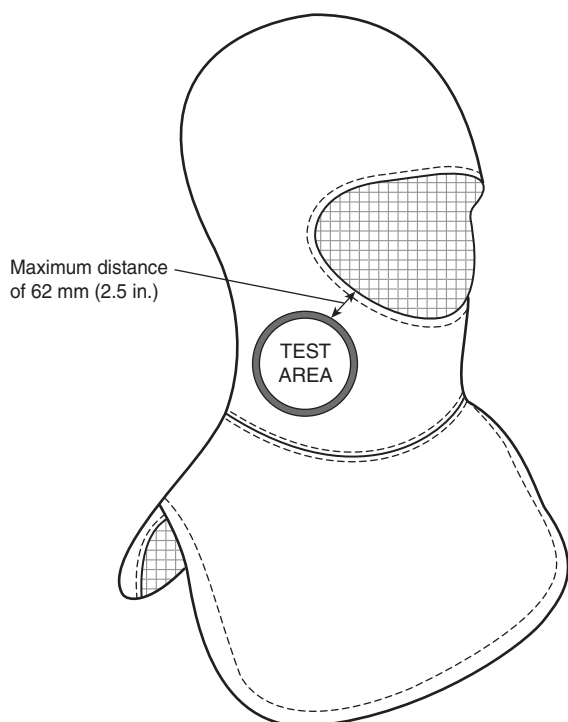

**N** FIGURE 12.1.2.2(b) Minimum Light Evaluation Areas on Right Front Side of Particulate-Blocking Hood.

**N 12.2.2.2** As a minimum, four areas of the hood shall be evaluated as follows:

- (1) The left side of the hood with the edge of the test area at least 62 mm (2.5 in.) away from the hood opening [see Figure 12.2.2.2(a)]
- (2) The right side of the hood with the edge of the test area at least 62 mm (2.5 in.) away from the hood opening [see Figure 12.2.2.2(b)]
- (3) The back of the hood [see Figure 12.1.2.2(c)]
- (4) The middle of any seam area joining two pieces of the particulate-blocking layer

**N 12.2.2.3** Other hood areas subject to 12.2.2.1 shall be permitted to be evaluated.

**N 12.2.3\* Evaluation Apparatus.**

**N 12.2.3.1 Approaches.**

**N 12.2.3.1.1 Qualitative.** The overall evaluation apparatus for the qualitative approach shall consist of a sample clamping device, a smoke generator, and a flowmeter.

**N 12.2.3.1.2 Quantitative.** The overall evaluation apparatus for the quantitative approach shall include a light transmission meter in addition to the same equipment used for the qualitative approach listed in 12.2.3.1.1.

**N 12.2.3.2\*** A sample clamping device shall be used that has the following characteristics:

- (1) The device shall provide a transparent cylindrical reservoir of a diameter of 100 mm  $\pm$  25 mm (4.0 in.  $\pm$  1.0 in.), a height of 140 mm  $\pm$  50 mm (5.5 in.  $\pm$  2.0 in.), and a wall thickness of at least 6 mm (0.25 in.) and shall have a minimum volume of 800 mL (50 in.<sup>3</sup>).

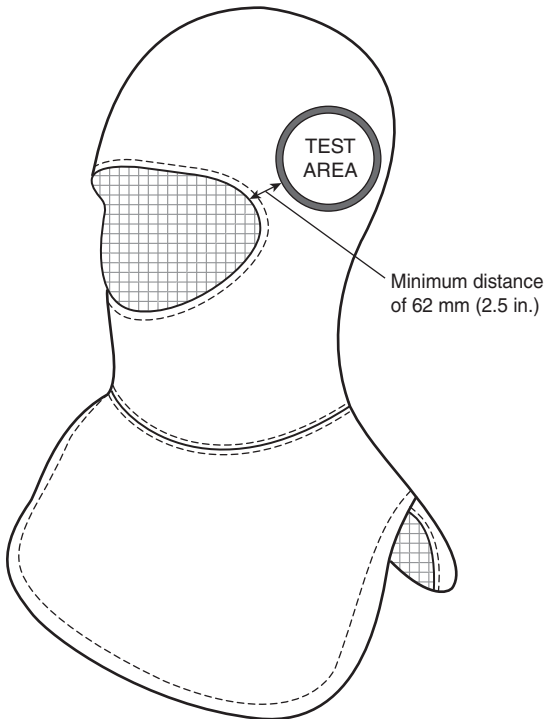

**N** FIGURE 12.2.2.2(a) Minimum Smoke Evaluation Areas on Left Front Side of Particulate-Blocking Hood.

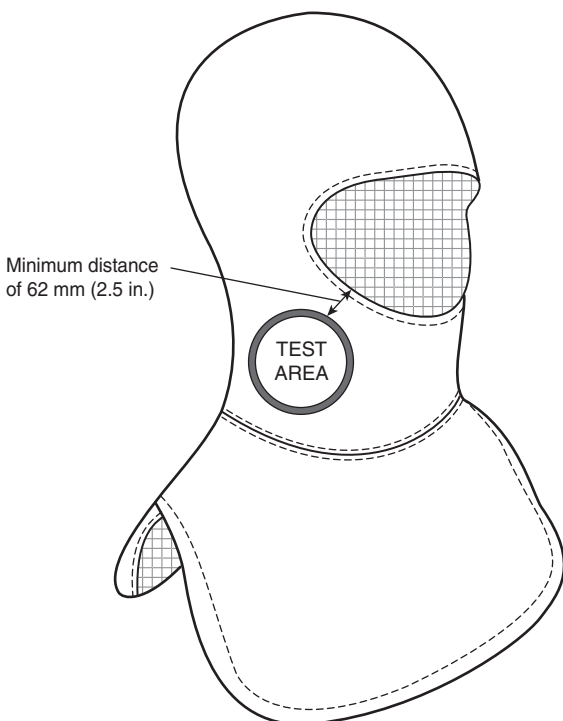

**N** FIGURE 12.2.2.2(b) Minimum Smoke Evaluation Areas on Right Front Side of Particulate-Blocking Hood.

- (2) A cylinder cap shall be placed on top of the reservoir that provides a minimum viewing area of 60 mm (2.4 in.) in diameter and shall provide a clamping surface that includes a rubber gasket between the cylinder cap and the reservoir.
- (3) The device shall have a means of clamping the portion of the hood interface component on top of the open cylindrical reservoir with a clamp such that all areas of the hood interface component incorporating the particulate-blocking layer can be evaluated and which creates an effective seal between the clamping mechanism and the clamping surface of the transparent cylindrical reservoir.
- (4) The device's transparent cylindrical reservoir shall have a fitting that permits a leak-free connection with a hose connected to the smoke generator.
- (5) A leak-free connection shall also be provided to the transparent cylindrical reservoir for the measurement of pressure inside the reservoir using a pressure gauge in kPa (psi).

**N 12.2.3.3\*** A smoke generator shall be used that has the following characteristics and capabilities:

- (1) The smoke generator shall have the capability of providing smoke through an orifice that establishes a direct, leak-free connection between the smoke generator and the sample clamping device.
- (2) The smoke generator shall have the ability to adjust the flow of smoke and shall have the capability to produce smoke at a rate of at least 1.0 to 2.5 L/min.
- (3) The smoke generator shall generate visible smoke based on a cosmetic grade mineral oil or an aqueous-based smoke-generating agent that provides smoke particles ranging from 1 to 10 microns.
- (4) When connected to the sample clamping device, the smoke generator shall not create a pressure greater than 1.0 kPa (0.15 psi) when operating for a period of 1 minute.

**N 12.2.3.4** A flowmeter, or a rotometer or other flow measurement device capable of measuring air flow rate in L/min to the nearest 0.1 L/min, shall be placed in the connection line from the smoke generator to the device's transparent cylindrical reservoir.

**N 12.2.3.5\*** A light transmission meter that consists of a light source and light receiver with the following characteristics shall be used for quantitative evaluation approaches:

- (1) The light source shall be a light-emitting diode (LED) source that generates a continuous tight beam of light.
- (2) The light receiver shall be a photoresistor capable of reporting light transmission from 0 to 100 percent on a digital display with an optional RS232 port for recording measurements.
- (3) The light transmission device shall be capable of being mounted on the sample clamping device such that the light beam is generated and received parallel to the test hood surface at a height of 34 mm  $\pm$  3 mm (1.3 in.  $\pm$  0.1 in.) and that there is a distance between the light source and light receiver of 90 mm  $\pm$  10 mm (3.5 in.  $\pm$  0.3 in.).

**N 12.2.4 Procedure.**

**N 12.2.4.1** The evaluation procedure shall be conducted indoors in a well-lit area that is free from air currents and provides good visibility.

**N 12.2.4.2** The qualitative evaluation approach shall be conducted using the following procedure:

- (1) The smoke generator shall be operated in accordance with the manufacturer's instructions by adding the appropriate smoke-generating liquid and any other supplies for its operation.
- (2) Prior to testing, the smoke generator shall be turned on and allowed to generate smoke for 5 minutes.
- (3) After 5 minutes, the smoke generator shall be switched to air to clean out the remaining smoke-generating liquid in the hose and to prepare for testing.
- (4) With the smoke generator still generating air and the hose not connected to the cylindrical reservoir, the hose shall be connected to the flowmeter and the flow rate shall be adjusted to 1.7 L/min  $\pm$  0.1 L/min.
- (5) Following adjustment of the flow rate, the smoke generator shall be switched to smoke and the hose shall be securely attached to the transparent cylindrical reservoir.
- (6) The hood shall be inverted (i.e., turned inside out) and the portion of the hood to be tested shall be positioned over the top of the transparent cylindrical reservoir and securely clamped into position.
- (7) The viewing area within the cylindrical clamping fixture shall be observed for up to 120 seconds for the presence of smoke coming through the clamped area of the hood interface component.
- (8) After 120 seconds, the smoke generator shall be turned off and the cylindrical chamber shall be flushed with air.
- (9) The hood interface component shall be removed from the sample clamping device, inspected, and subjected to an advanced cleaning, if necessary.
- (10) The interior of the cylindrical reservoir shall be wiped to remove any chemical residue and the hose shall be detached and turned upside down to clear out any residual smoke or smoke-generating liquid.
- (11) Each area of the hood specified in 12.2.2 shall be evaluated.
- (12) The level of smoke-generating liquid shall be checked at the conclusion of testing to ensure that it has not decreased more than 50 percent, in which case additional smoke-generating liquid shall be added to bring the liquid reservoir up to its full capacity.
- (13)\* Following testing, the hood interface component shall be cleaned to remove any residue remaining from the smoke content.

**N 12.2.4.3** The quantitative evaluation approach shall be conducted using the same procedures in 12.2.4.2 with the following additional procedures:

- (1)\* The light transmission meter shall be calibrated before each set of measurements using a standard reference material that provides a range of light transmission from 40 percent to 90 percent.
- (2) Light transmission readings shall be taken every 10 seconds for the last 60 seconds of the 120 seconds required in 12.2.4.2(7).

#### **N 12.2.5 Results.**

**N 12.2.5.1** For the qualitative evaluation approach, observations of smoke coming out of each evaluated area of the hood interface component shall be reported.

**N 12.2.5.2** For the quantitative evaluation approach, the measured light transmission values recorded from 60 to 120 seconds

shall be reported and the average transmission value for each hood shall be calculated.

#### **N 12.2.6 Interpretation.**

**N 12.2.6.1** For the qualitative evaluation approach, any observed smoke coming out of the test hood relative to an unused, pristine hood shall be considered as a possible indication of a defect or other damage that compromises the hood's performance.

**N 12.2.6.2\*** For the quantitative evaluation approach, any decrease in a light transmission value of 5 percent or more relative to an unused, pristine hood shall be considered as possible evidence of a defect or other damage that compromises the hood's performance.

#### **12.3 Water Penetration Barrier Evaluation.**

**12.3.1 Application.** This test method shall apply to moisture barrier materials and moisture barrier seams found in structural or proximity fire fighting protective garment elements that are in service and to moisture barrier repairs that are being subjected to advance repair procedures by an ISP or organization for verification.

##### **12.3.2 Evaluation Areas.**

**12.3.2.1** For the purposes of evaluating in-service garment elements, a minimum of three moisture barrier material areas and a minimum of three moisture barrier areas with a seam shall be tested on each garment element.

**12.3.2.1.1** Moisture barrier material areas shall be from high-abrasion areas of the garment elements, including, but not limited to:

- (1) Broadest part of the shoulders
- (2) Back waist area of the coat
- (3) Knees
- (4) Crotch area
- (5) Seat area

**12.3.2.1.2** In addition to the areas listed in 12.3.2.1.1 where potential damage to the garment outer shell or the thermal barrier has been detected, the evaluation shall be conducted on the corresponding area of the moisture barrier. Where potential damage to the garment moisture barrier has been detected, the evaluation shall also be conducted on that area of the moisture barrier.

**N 12.3.2.2** For the purposes of verification, a minimum of three repaired samples of each moisture barrier for verification shall be prepared according to 11.3.8.2.

**12.3.2.3** Moisture barrier material areas shall be positioned in the evaluation apparatus such that the side of the barrier that is against the outer shell faces the water in the evaluation apparatus.

**12.3.2.4** Moisture barrier material areas with seams shall be positioned on the evaluation apparatus so that the seam divides the specimen into two equal halves.

##### **12.3.3 Evaluation Apparatus.**

**12.3.3.1\*** The apparatus used to evaluate water penetration shall have the following characteristics:

- (1) The apparatus shall consist of a means of clamping the area to be evaluated in a horizontal position, providing a

- watertight seal with the pressurized portion of the apparatus and water reservoir.
- (2) The apparatus shall accommodate evaluations of moisture barriers and seams without the removal of the specimens.
  - (3) The apparatus shall have a clamping area that provides a water exposure and viewing area that is at least 50 mm (2 in.) in diameter.
  - (4) The apparatus shall have a water reservoir containing sufficient water for carrying out the evaluation.
  - (5) The apparatus shall provide for the pressurization of water against the garment element moisture barrier area at a pressure of 6.9 kPa (1 psi) for at least 15 seconds. The 6.9 kPa (1 psi) pressure shall be achieved within 10 seconds.
  - (6) The apparatus shall be equipped with a pressure gauge that is accurate to the nearest 0.2 kPa (0.1 psi).
  - (7) The apparatus shall be equipped with a means of bleeding air pressure and permit the drainage of water from the pressurized portion of the apparatus.

**12.3.3.2** A stopwatch or other timer shall be used to ensure that pressure is applied for the specified duration of 15 seconds.

#### **12.3.4 Procedure.**

**12.3.4.1** The evaluation shall be conducted using the following procedure:

- (1) The selected area of moisture barrier shall be placed in the apparatus and clamped to provide a watertight seal with the apparatus.
- (2) A water pressure of 1 psi shall be introduced against the moisture barrier for a period of not less than 15 seconds.
- (3) The visible side of the moisture barrier shall be visually inspected after 15 seconds to determine if water penetration has occurred.

#### **12.3.5 Results.**

**12.3.5.1** If any water passes through the moisture barrier or moisture barrier seam, the liner shall be removed from service and repaired or replaced.

**12.3.5.2** If no water passes through the moisture barrier or moisture barrier seam, the liner shall be allowed to dry completely before being returned to service.

### **N 12.4 Chemical Decontamination Efficacy Test.**

**N 12.4.1\* Application.** This test method shall determine the chemical decontamination efficacy for outer shell materials in protective garments that are subjected to advanced cleaning procedures by a cleaning facility for the removal of products of combustion from structural fire-fighting protective garments.

#### **N 12.4.2\* General Procedures.**

**N 12.4.2.1** The certification organization or its designated laboratory shall contaminate separate sets of selected outer shell material specimens with semivolatile organic compounds and heavy metals.

**N 12.4.2.2** Chemically contaminated and noncontaminated specimens of the selected outer shell material shall be prepared, appropriately packaged, and sent by the certification organization to the respective cleaning facility with the supplies necessary for subjecting the specimens to the cleaning facility's advanced cleaning procedures.

**N 12.4.2.3** Under the supervision of a representative from the certification organization, ISP personnel shall insert the chemically contaminated and noncontaminated outer shell specimens into surrogate clothing samples that shall then be specially placed with designated ballast materials in the cleaning facility's advanced cleaning equipment to form the wash load.

**N 12.4.2.4** The surrogate clothing samples with chemically contaminated and noncontaminated outer shell specimens and designated ballast material shall be subjected to one full cycle of the cleaning facility's advanced cleaning procedures.

**N 12.4.2.5** Following the completion of the cleaning facility's advanced cleaning procedures and under the supervision of a representative from the certification organization, the washed chemically contaminated and noncontaminated outer shell specimens shall be removed by cleaning facility personnel, placed in suitable containers, and shipped back to the certification organization or its designated laboratory.

**N 12.4.2.6** The certification organization or its designated laboratory shall analyze the washed chemically contaminated and noncontaminated specimens as well as control specimens (i.e., contaminated but not laundered) and determine the cleaning efficiency of the cleaning facility's advanced cleaning procedures for each of the specified chemical contaminants.

**N 12.4.2.7** The certification organization shall separately interpret the cleaning efficiency results for both heavy metals and semivolatile organic compounds to determine compliance with the criteria for the respective cleaning facility cleaning efficiency specified in 11.3.7.

#### **N 12.4.3 Specimen Preparation.**

**N 12.4.3.1** The garment outer shell used for specimens shall be an undyed 60 percent para-aramid/40 percent polybenzimidazole (PBI) base fabric with a reinforcement grid meeting the following specifications:

- (1) The outer shell fabric shall have a unit area weight of 240 to 268 g/m<sup>2</sup> (7.1 to 7.9 oz/yd<sup>2</sup>).
- (2) The outer shell fabric shall have a thickness of 0.584 ± 0.254 mm (0.023 ± 0.10 in.).
- (3) The outer shell fabric shall have a water absorption resistance of less than 5 percent when tested in accordance with Section 8.25 of NFPA 1971.

**N 12.4.3.2** Outer shell fabric used for testing shall be prepared by laundering for 10 cycles as specified in AATCC 135, *Dimensional Changes of Fabrics after Home Laundering*, using Machine Cycle 1, Wash Temperature V, and Drying Procedure Ai. A 1.82 kg ± 0.1 kg (4.0 lb ± 0.2 lb) load shall be used. A laundry bag shall not be used.

#### **N 12.4.3.3 Semivolatile Organic Compounds.**

**N 12.4.3.3.1** A minimum of six specimens shall be contaminated with selected semivolatile organic compounds as specified in 12.6.1 and 12.6.2.

**N 12.4.3.3.1.1** The number of contaminated specimens required by 12.4.3.3.1.1 shall be permitted to be reduced from six to five specimens if the certification organization can demonstrate that the transportation of the specimens to the cleaning facility does not affect the travel specimen's condition or the contaminant concentrations.

- N 12.4.3.3.2** Four additional specimens shall be prepared as specified in 12.4.3.2 but not contaminated.
- N 12.4.3.3.2.1** The number of noncontaminated specimens required by 12.4.3.3.2 shall be permitted to be reduced from four to three specimens if the certification organization can demonstrate that the transportation of the specimens to the receiving facility does not affect the travel specimen's condition.
- N 12.4.3.3.3** One contaminated specimen and one noncontaminated specimen shall remain at the certification organization or its designated laboratory.
- N 12.4.3.4 Heavy Metals.**
- N 12.4.3.4.1** A minimum of six specimens shall be contaminated with selected heavy metals as specified in 12.7.1 and 12.7.2.
- N 12.4.3.4.1.1** The number of contaminated specimens required by 12.4.3.4.1 shall be permitted to be reduced from six to five specimens if the certification organization can demonstrate that the transportation of the specimens to the cleaning facility does not affect the travel specimen's condition or the contaminant concentrations.
- N 12.4.3.4.2** Four additional specimens shall be prepared as specified in 12.4.3.2 but not contaminated.
- N 12.4.3.4.2.1** The number of noncontaminated specimens required by 12.4.3.4.2 shall be permitted to be reduced from four to three specimens if the certification organization can demonstrate that the transportation of the specimens to the receiving facility does not affect the travel specimen's condition.
- N 12.4.3.4.3** One contaminated specimen and one noncontaminated specimen shall remain at the certification organization or its designated laboratory.
- N 12.4.4 Specimen Handling, Sample Wash Load Assembly, and Cleaning.**
- N 12.4.4.1 General.** Each individual contaminated and noncontaminated specimen shall be placed in a separate contamination-free container with a label identifying the specimen and shipped overnight by the certification organization or its designated laboratory to the cleaning facility for receipt on the scheduled day of testing.
- N 12.4.4.2 Surrogate Garments.**
- N 12.4.4.2.1** The certification organization or its designated laboratory shall provide surrogate garments that have been prepared as specified in 12.9.1.
- N 12.4.4.2.2** The surrogate garments shall be permitted to be provided separately from the contamination and noncontaminated specimens.
- N 12.4.4.3 Ballast Material Panels.**
- N 12.4.4.3.1** The certification organization shall either provide or have the cleaning facility use a white, plain weave, 100 percent polyester ballast fabric that conforms to the following specifications:
- (1) The ballast fabric shall have a unit area weight of  $346 \pm 34 \text{ g/m}^2$  ( $10.2 \pm 1.0 \text{ oz/yd}^2$ ).
  - (2) The ballast fabric shall have a construction of at least 35 threads in the warp direction and at least 20 threads in the fill or weft direction.
  - (3) The ballast fabric shall be uncoated and have a durable water repellent finish that results in a horizontal wicking of less than 10 mm (0.40 in.) in any direction when tested as specified in AATCC 198, *Horizontal Wicking of Textiles*, after the fabric has been washed a total of 5 cycles as specified in AATCC 135, *Dimensional Changes of Fabrics after Home Laundering*.
  - (4) The ballast fabric shall have a tensile strength of at least 1560 N (350 lb) when tested as specified in ASTM D5034, *Standard Test Method for Breaking Strength and Elongation of Textile Fabrics (Grab Test)*.
  - (5) The ballast fabric shall have a tear strength of at least 116 N (26 lb) when tested as specified in ASTM D2261, *Standard Test Method for Tearing Strength of Fabrics by the Tongue (Single Rip) Procedure (Constant-Rate-of-Extension Tensile Testing Machine)*.
- N 12.4.4.3.2** An alternative ballast material shall be permitted if it is shown to have at least the same weight range specified in 12.4.4.3.1(1) and meets the horizontal wicking requirement in 12.4.4.3.1(3).
- N 12.4.4.3.3** A sufficient number of different cut and shaped ballast fabric-based wash panels for creating the wash load shall be prepared in advance of the testing as specified in 12.9.2.
- N 12.4.4.4 Handling and Disposition of Contaminated Specimens.**
- N 12.4.4.4.1\*** Under the supervision of a representative from the certification organization, the chemically contaminated and noncontaminated outer shell fabric test specimens shall be unpacked with the following disposition as related separately to both semivolatiles organic compounds and heavy metals:
- (1) One contaminated specimen and one noncontaminated specimen shall remain in their containers, untouched at the receiving facility, and shall be identified as the "travel specimens." These specimens shall be permitted to be excluded if the certification organization can demonstrate that the transportation of the specimens to the cleaning facility does not affect the specimen's condition or the contaminant concentrations.
  - (2) One noncontaminated specimen shall be inserted in Specimen Pocket 1 of the surrogate coat; one individual contaminated specimen shall be inserted in Specimen Pocket 2 of the surrogate coat, while a second individual contaminated specimen shall be inserted in Specimen Pocket 3 of the surrogate coat.
  - (3) One noncontaminated specimen shall be inserted in Specimen Pocket 1 of the surrogate pant; one individual contaminated specimen shall be inserted in Specimen Pocket 2 of the surrogate pant, while a second individual contaminated specimen shall be inserted in Specimen Pocket 3 of the surrogate pant.
- N 12.4.4.4.2** The individual handling the specimens shall be wearing clean disposable gloves and shall use either metal tweezers for semi-volatile organic compound-contaminated specimens or plastic tweezers for heavy metal-contaminated specimens provided by the certification organization for inserting the specimens into the surrogate clothing item pockets.

- N 12.4.4.4.3** The tweezer surfaces that contact the specimens shall be cleaned with an alcohol solution-based disposable wipe between uses.
- N 12.4.4.4.5 Assembly of Wash Load and Application of Wash Load.**
- N 12.4.4.5.1** The wash load shall be assembled as specified in 12.9.3 and adjusted according to the cleaning facility's procedures for load size.
- N 12.4.4.5.2** If the cleaning facility's procedures for advanced cleaning involve a pretreatment, such as a presoaking of clothing prior to placement in a washer/extractor or other type of laundering machine, then it shall be permitted to subject only the surrogate clothing with inserted outer shell specimens to the pretreatment without the ballast materials.
- N 12.4.4.5.3** The wash load consisting of the surrogate clothing items with inserted outer shell fabric specimens, along with the specified number and types of ballast fabric-based wash panels, shall be subject to the cleaning facility's advanced cleaning procedures for which verification is being performed.
- N 12.4.4.5.3.1** The inserted outer shell specimens shall be permitted to be removed from the respective surrogate clothing items for faster drying using appropriate tweezers for the type of sample and minimizing any contact or handling with the specimen before drying is complete.
- N 12.4.4.5.4** To shorten the drying time, the surrogate clothing items with inserted outer shell specimens shall be allowed to dry without the ballast fabric-based wash panels.
- N 12.4.4.6 Removal and Shipping.** Following the advanced cleaning and under the supervision of a representative from the certification organization, the specimens shall be removed from the surrogate clothing items using tweezers, placed in labeled, contamination-free containers, and packaged for overnight shipment to the certification organization or its designated laboratory for evaluation.
- N 12.4.5 Specimen Evaluation.**
- N 12.4.5.1** Test specimens for semivolatile organic compound contamination removal shall be subject to the extraction and analysis procedures specified in 12.6.3 through 12.6.5.
- N 12.4.5.2** Test specimens for heavy metal contamination removal shall be subject to the extraction and analysis procedures specified in 12.7.3 and 12.7.4.
- N 12.4.6 Report.** The following information shall be reported for each contaminant:
- (1) Contaminant concentration in the contaminated specimen that stayed at the certification organization or its designated laboratory
  - (2) Contaminant concentration in the contaminated, traveling specimen, if applicable
  - (3) Contaminant concentration in the unwashed, traveling specimen, if applicable
  - (4) Contaminant concentration in each of the washed specimens
  - (5) Average contaminant concentration of the washed specimens
  - (6) Contaminant concentration in the washed, blank specimen
  - (7) Calculated cleaning efficiency by contaminant
- (8) The average calculated cleaning efficiency for all contaminants
- N 12.4.7 Interpretation.**
- N 12.4.7.1** Overall compliance with the requirement for chemical decontamination involving semivolatile organic compound contaminants shall be based on the average calculated cleaning efficiency for all chemical contaminants.
- N 12.4.7.2** Overall compliance with the requirement for chemical decontamination involving heavy metals shall be based on the average calculated cleaning efficiency for all chemical contaminants.
- N 12.5 Biological Decontamination Efficacy Test.**
- N 12.5.1\* Application.** This test method shall determine the biological decontamination efficacy for outer shell materials in protective garments that are subjected to cleaning facility procedures for the disinfection or sanitization of structural fire-fighting protective garments.
- N 12.5.2\* General Procedures.**
- N 12.5.2.1** The certification organization or its designated laboratory shall contaminate sets of selected outer shell material specimens with the two specific microorganisms.
- N 12.5.2.2** Biologically contaminated and noncontaminated specimens of the selected outer shell material shall be prepared, appropriately packaged, and sent by the certification organization to the respective ISP with the supplies necessary for subjecting the specimens to the cleaning facility's sanitization procedures.
- N 12.5.2.3** Under the supervision of a representative from the certification organization, cleaning facility personnel shall insert the biologically contaminated and noncontaminated outer shell specimens into surrogate clothing samples that shall then be specially placed with designated ballast materials in the cleaning facility's sanitization equipment to form the wash load.
- N 12.5.2.4** The surrogate clothing samples with biologically contaminated and noncontaminated outer shell specimens and designated ballast material shall be subjected to one full cycle of the cleaning facility's sanitization procedures.
- N 12.5.2.5** Following completion of the cleaning facility's sanitization cleaning procedures and under the supervision of a representative from the certification organization, the washed biologically contaminated and noncontaminated outer shell specimens shall be removed by cleaning facility personnel, placed in suitable containers, and shipped back to the certification organization or its designated laboratory.
- N 12.5.2.6\*** The certification organization or its designated laboratory shall analyze the washed biologically contaminated and noncontaminated specimens as well as control specimens (contaminated but not laundered) and determine the log reduction of the cleaning facility's advanced sanitization procedures for each of the specified biological contaminants.
- N 12.5.2.7** The certification organization shall separately interpret the log reduction results for each selected microorganism to determine compliance with the criteria for the respective cleaning facility sanitization efficiency specified in 11.3.7.

**N 12.5.3 Specimen Preparation.**

**N 12.5.3.1** The garment outer shell material used for specimens shall be an undyed 60 percent para-aramid/40 percent PBI base fabric with a reinforcement grid and shall meet the following specifications:

- (1) The outer shell fabric shall have a unit area weight of 240 to 268 g/m<sup>2</sup> (7.1 oz/yd<sup>2</sup> to 7.9 oz/yd<sup>2</sup>).
- (2) The outer shell fabric shall have a thickness of 0.584 mm ± 0.254 mm (0.023 in. ± 0.10 in.).
- (3) The outer shell fabric shall have a water absorption resistance of less than 5 percent when tested in accordance with Section 8.25 of NFPA 1971.

**N 12.5.3.2** A total of two specimens shall be prepared for each bacterium as specified in Section 12.8, and outer shell fabric to be used for testing shall be prepared by laundering for 10 cycles as specified in AATCC 135, *Dimensional Changes of Fabrics after Home Laundering*, using Machine Cycle 1, Wash Temperature V, and Drying Procedure Ai. A 1.82 kg ± 0.1 kg (4.0 lb ± 0.2 lb) load shall be used. A laundry bag shall not be used.

**N 12.5.3.3** A minimum of six specimens shall be contaminated with each bacterium as specified in 12.8.2.

**N 12.5.3.3.1** The number of contaminated specimens required by 12.5.3.3 shall be permitted to be reduced from six to five specimens if the certification organization can demonstrate that the transportation of the specimens to the cleaning facility does not affect the travel specimen's condition or the bacterial contamination level.

**N 12.5.3.4** Four additional specimens shall be prepared for each type of bacteria as specified in 12.5.3.2 but not contaminated.

**N 12.5.3.4.1** The number of noncontaminated specimens required by 12.5.3.4 shall be permitted to be reduced from four to three specimens if the certification organization can demonstrate that the transportation of the specimens to the cleaning facility does not result in the inadvertent biocontamination of the travel specimen.

**N 12.5.3.5** One contaminated specimen and one noncontaminated specimen shall remain at the certification organization or its designated laboratory.

**N 12.5.4 Specimen Handling, Sample Load Assembly, and Sanitization.**

**N 12.5.4.1 General.** Each individual contaminated and noncontaminated specimen shall be placed in a separate sterile container with a label identifying the specimen and shipped overnight by the certification organization or its designated laboratory to the cleaning facility for receipt on the scheduled day of testing.

**N 12.5.4.1.1** Specimens shall be shipped in a manner to maintain their temperature at 4°C (39°F) prior to testing at the cleaning facility.

**N 12.5.4.2 Surrogate Garments.**

**N 12.5.4.2.1** The certification organization or its designated laboratory shall provide surrogate garments that have been prepared as specified in 12.9.1.

**N 12.5.4.2.2** Prior to shipping, each surrogate garment shall be autoclaved for 90 minutes at 121°C (250°F) and then packaged

in a manner to maintain the garments' sterility prior to use at the cleaning facility.

**N 12.5.4.2.3** The surrogate garments shall be permitted to be provided separately from the contamination and noncontaminated specimens.

**N 12.5.4.3 Ballast Material Panels.**

**N 12.5.4.3.1** The certification organization shall either provide or have the cleaning facility use a white, plain weave, 100 percent polyester ballast fabric that conforms to the following specifications:

- (1) The ballast fabric shall have a unit area weight of 346 g/m<sup>2</sup> ± 34 g/m<sup>2</sup> (10.2 oz/yd<sup>2</sup> ± 1.0 oz/yd<sup>2</sup>).
- (2) The ballast fabric shall have a construction of at least 35 threads in the warp direction and at least 20 threads in the fill or weft direction.
- (3) The ballast fabric shall be uncoated and have a durable water repellent finish that results in a horizontal wicking of less than 10 mm (0.40 in) in any direction when tested as specified in AATCC 198, *Horizontal Wicking of Textiles*, after the fabric has been washed a total of 5 cycles as specified in AATCC 135, *Dimensional Changes of Fabrics after Home Laundering*.
- (4) The ballast fabric shall have a tensile strength of at least 1560 N (350 lb) when tested as specified in ASTM D5034, *Standard Test Method for Breaking Strength and Elongation of Textile Fabrics (Grab Test)*.
- (5) The ballast fabric shall have a tear strength of at least 116 N (26 lb) when tested as specified in ASTM D2261, *Standard Test Method for Tearing Strength of Fabrics by the Tongue (Single Rip) Procedure (Constant-Rate-of-Extension Tensile Testing Machine)*.

**N 12.5.4.3.2** An alternative ballast material shall be permitted if it is shown to have at least the same weight range specified in 12.4.4.3.1(1) and meets the horizontal wicking requirement in 12.4.4.3.1(3).

**N 12.5.4.3.3** A sufficient number of different cut and shaped ballast fabric-based wash panels for creating the wash load shall be prepared in advance of the testing as specified in 12.9.2.

**N 12.5.4.4 Handling and Disposition of Contaminated Specimens.**

**N 12.5.4.4.1\*** Under the supervision of a representative from the certification organization, the biologically contaminated and noncontaminated outer shell fabric test specimens shall be unpacked with the following disposition as related separately to both types of bacteria:

- (1) One contaminated specimen and one noncontaminated specimen shall remain in their containers, untouched at the cleaning facility, and shall be identified as the "travel specimens." These specimens shall be permitted to be excluded if the certification organization can demonstrate that the transportation of the specimens to the cleaning facility does not affect the travel specimen's condition or the biological contamination level.
- (2) One noncontaminated specimen shall be inserted in Specimen Pocket 1 of the surrogate coat; one individual contaminated specimen shall be inserted in Specimen Pocket 2 of the surrogate coat, while a second individual contaminated specimen shall be inserted in Specimen Pocket 3 of the surrogate coat.



- (3) One noncontaminated specimen shall be inserted in Specimen Pocket 1 of the surrogate pant; one individual contaminated specimen shall be inserted in Specimen Pocket 2 of the surrogate pant, while a second individual contaminated specimen shall be inserted in Specimen Pocket 3 of the surrogate pant.
- N 12.5.4.4.2** The individual handling the specimens shall be wearing clean disposable gloves and shall use tweezers provided by the certification organization for inserting the specimens into the surrogate clothing item pockets.
- N 12.5.4.4.3** The tweezer surfaces that contact the specimens shall be cleaned with an alcohol solution-based disposable wipe between uses.
- N 12.5.4.5 Assembly of Sanitization Load and Application of Sanitization.**
- N 12.5.4.5.1** The sanitization load shall be assembled as specified in 12.9.3 and adjusted according to the cleaning facility's procedures for load size.
- N 12.5.4.5.2** If the cleaning's procedures for sanitization involve a pretreatment, such as a presoaking of clothing prior to placement in a washer/extractor or other type of laundering machine, then it shall be permitted to subject only the surrogate clothing with inserted outer shell specimens to the pretreatment without the ballast materials.
- N 12.5.4.5.3** The sanitization load consisting of the surrogate clothing items with inserted outer shell fabric specimens, along with the specified number and types of ballast fabric-based wash panels, shall be subject to the cleaning facility's sanitization procedures for which verification is being performed.
- N 12.5.4.5.4** To shorten the drying time, the surrogate clothing items with inserted outer shell specimens shall be allowed to dry without the ballast fabric-based wash panels.
- N 12.5.4.5.4.1** It shall be permitted to remove the inserted outer shell specimens from the respective surrogate clothing items for faster drying using appropriate tweezers for the type of sample and minimizing any contact or handling with the specimen before drying is complete.
- N 12.5.4.5.5** Following the sanitization process and under the supervision of a representative from the certification organization, the specimens shall be removed from the surrogate clothing items using tweezers, placed in labeled, contamination-free containers, and packaged for overnight shipment to the certification organization or its designated laboratory for evaluation.
- N 12.5.5 Specimen Evaluation.** Test specimens for determining sanitization shall be subject to the extraction and analysis procedures specified in 12.8.3.
- N 12.5.6 Report.** The following information shall be reported for each bacterial contaminant in each outer shell material:
- (1) Original bacterial count applied to each specimen
  - (2) Post-cleaning bacterial count for the unwashed, traveling specimen, if applicable
  - (3) Post-cleaning bacterial count for each of the washed specimens, if applicable
  - (4) Average post-cleaning bacterial count for the washed specimens
  - (5) Post-cleaning bacterial count for the washed, blank specimen
  - (6) Calculated log<sub>10</sub> reduction
- N 12.5.7 Interpretation.** Overall compliance with the requirements for biological decontamination shall be based on the individual reported log<sub>10</sub> reduction for each biological contaminant.
- N 12.6 Semi-Volatile Organic Compound Contained Specimen Preparation, Extraction, and Analysis.**
- N 12.6.1 Selection of Contaminants.** The following semivolatile organic compounds shall be prepared at a concentration of 200 ppm in a 1:1 mixture of benzene and methylene chloride:
- (1) Acenaphthene (CAS No. 83-32-9)
  - (2) Anthracene (CAS No. 120-12-7)
  - (3) Diethyl phthalate (CAS No. 84-66-2)
  - (4) Di-n-octyl phthalate (CAS No. 117-84-0)
  - (5) Fluorene (CAS No. 86-73-7)
  - (6) Phenanthrene (CAS No. 85-01-8)
  - (7) Pyrene (CAS No. 129-00-0)
  - (8) 2-Nitrophenol (CAS No. 88-75-5)
  - (9) Phenol (CAS No. 108-95-2)
  - (10) 2,4,6-Trichlorophenol (CAS No. 88-06-2)
- N 12.6.2 Procedures for Contamination of Specimens.**
- N 12.6.2.1** Outer shell fabric prepared as specified in 12.4.3.2 shall be cut into 75 mm × 150 mm (3 in. × 6 in.) specimens.
- N 12.6.2.2** Using a gastight syringe, a volume of 300 µL of the polycyclic aromatic hydrocarbons (PAH)/phthalate/phenols contamination mixture specified in 12.6.1 shall be dispensed uniformly onto each specimen by drawing the solution into the syringe and slowly depressing the plunger onto the specimen while gently rubbing the end of the syringe onto the specimen.
- N 12.6.2.3** Contaminated specimens shall be permitted to dry under ambient laboratory conditions for no more than 30 minutes following the application of the PAH/phthalate/phenols mixture.
- N 12.6.2.4** The specimen shall be placed in a labeled jar or other container and kept in a refrigerator at 4°C (39°F) until ready for shipping.
- N 12.6.2.5** Alternative techniques for contaminating the specimens shall be permitted if it can be demonstrated that the selected technique provides a specimen concentration of the specific contaminant(s) that are ±20 percent of the target concentration following the application of the technique.
- N 12.6.3 Extraction of Specimens.**
- N 12.6.3.1** All labware, jars, or extraction vessels made of glass or other degradation-resistant and contamination-free materials shall be thoroughly cleaned, rinsed, and dried.
- N 12.6.3.1.1** Where specified, other types of labware shall be substituted if it can be demonstrated that the labware will not contribute to cross contamination of the extraction liquids.
- N 12.6.3.2** An extraction solvent of 50 percent methylene chloride, 25 percent acetonitrile, 25 percent cyclohexane shall be prepared.
- N 12.6.3.3** A PAH/phthalate/phenols dilution solution of a 1:1 ratio of benzene and methylene chloride shall be prepared.
- N 12.6.3.4** The specimen to be analyzed shall be cut into eight smaller pieces and placed in a 300 mL (10.1 oz) extraction vessel with a lid.

- N 12.6.3.5** Six 16 mm ( $\frac{5}{8}$  in.) polytetrafluoroethylene (PTFE) bearing balls shall be placed in the extraction vessel with the cut specimen pieces.
- N 12.6.3.6** A volume of 50 mL (1.7 oz) of the extraction solvent prepared per 12.6.3.2 shall be added to the extraction vessel.
- N 12.6.3.7** The extraction vessel shall be placed on a platform shaker set at 230 RPM  $\pm$  10 RPM and shall be shaken for 30 minutes.
- N 12.6.3.8** The extraction vessel shall be removed from the platform shaker and shall be placed in a sonicator for 20 minutes at a “no heat” condition.
- N 12.6.3.9** Immediately after sonification has been concluded, the extraction vessel shall be vented by lifting the lid to prevent the creation of a vacuum within the vessel.
- N 12.6.3.10** The specimens shall be allowed to rest in the extraction vessel until it has returned to room temperature after approximately 10–15 minutes.
- N 12.6.3.11** The resulting solution in the extraction vessel shall be filtered using a glass vacuum filtration flask assembly, with a 45 mm (1.77 in.) glass fiber filter placed on the fritted surface of the filtration apparatus and the apparatus then clamped to the flask and connected to a laboratory vacuum line.
- N 12.6.3.12** The glass filtration flask and specimen pieces shall be rinsed with 5 mL of extraction solvent.
- N 12.6.3.13** Any excess solvent shall be squeezed from the specimen pieces into the filtration flask.
- N 12.6.3.14** The liquid content of the vacuum filtration flask shall be transferred to an oil tube or other graduated condensation vessel suitable for measuring extract evaporation using a small glass funnel.
- N 12.6.3.15** Modifications to the specimen extraction procedures provided in 12.6.3.1 through 12.6.3.13 shall be permitted, provided that extraction recovery average efficiencies of 80 percent or better can be demonstrated.
- N 12.6.4 Preparation of Extract for Analysis.**
- N 12.6.4.1\*** The condensation vessel and contents prepared as specified in 12.6.3 shall be placed on the rack under a miniature evaporator/concentrator that is connected to ultra-high-purity nitrogen, and the contents shall be evaporated to less than or equal to 2 mL.
- N 12.6.4.2** After reconstitution, the condensation vessel shall be placed in a vortex tube and vortexed 10–15 seconds to incorporate any solids that have dried on the side of the tube.
- N 12.6.4.3** The contents of the vortex tube shall be measured using a disposable sterile pipette and the volume shall be recorded.
- N 12.6.4.4** The contents of the vortex tube shall be returned to the oil tube with an appropriate amount of solvent to increase the final volume to 2 mL.
- N 12.6.4.5** The oil tube shall be vortexed and the contents shall be transferred with a disposable glass pipette into 10 mL glass beaker.
- N 12.6.4.6** The contents from the beaker shall be removed using a 3 mL syringe with an attached polyvinylidene fluoride (PVDF) 0.45  $\mu$ m syringe.
- N 12.6.4.7** The contents of the syringe shall be filled into auto-sampler vial.
- N 12.6.4.8\*** Alternative procedures for preparing the extract for analysis shall be permitted, provided that extraction recovery average efficiencies of 80 percent or better can be demonstrated.
- N 12.6.5 Analysis of Specimens.**
- N 12.6.5.1** Calibration curves shall be prepared for each contaminant by applying known concentrations to specimen fabrics and extracting the specimens using the procedures specified in 12.6.3 and 12.6.4 using the analysis conditions specified in 12.6.5.2.
- N 12.6.5.2** Extracts prepared as specified in 12.6.4 shall be analyzed using gas chromatography and mass spectroscopy using the following analysis parameters:
- (1) A fused silica nonpolar 30 m, 0.25 mm ID, 0.50  $\mu$ m mass spectroscopy column with a guard column that has been deactivated but not coated with stationary phase
  - (2) Inlet temperature of 200°C (392°F)
  - (3) Transfer line temperature of 300°C (572°F)
  - (4) Ion source temperature of 300°C (572°F)
  - (5) Oven temperature of 60°C (140°F); held for 2 minutes
  - (6) Temperature ramp of 7°C (44.6°F) per minute to 310°C (590°F); held for 10 minutes
  - (7) A carrier gas of ultra-high-purity helium at 1.2 L/min (40.6 oz)
  - (8) 1  $\mu$ L sample splitless injection via autosampler into inlet containing split/splitless straight with wool topaz liner
- N 12.6.5.3** The output from the gas chromatography and mass spectroscopy shall be used to integrate and calculate the concentration of each chemical per mass of specimen remaining with the percentage removal based on the calibration curves.
- N 12.6.5.3.1** The concentration in each specimen shall be reported in  $\mu$ g/g specimen.
- N 12.6.5.4** Cleaning efficiency shall be calculated for each contaminant with the following equation and as specified in 12.6.5.4.1 and 12.6.5.4.2:

[12.6.5.4]

$$\text{cleaning efficiency} = 1 - \left[ \frac{(C_C - C_M) - (C_W - C_P)}{C_C - C_M} \right] \times 100$$

where:

 $C_C$  = contaminated specimen $C_M$  = material specimen (unwashed, not contaminated) $C_W$  = contaminated specimen (washed) $C_P$  = material specimen (washed, not contaminated)

**N 12.6.5.4.1** The actual masses used in the calculation of cleaning efficiency shall be the specific measured concentration of contaminant.

**N 12.6.5.4.2** If the measured mass is below the detection limit, a value of “0” shall be used.

- N 12.6.5.5** The average cleaning efficiency shall be determined for all contaminants.
- N 12.6.5.5.1** If any cleaning efficiencies are indicated as being above 100 percent, a cleaning efficiency of 100 percent shall be used for the purpose of calculating the average cleaning efficiency.
- N 12.6.5.5.2** If any cleaning efficiencies are indicated as being below 0 percent, a cleaning efficiency of 0 percent shall be used for the purpose of calculating the average cleaning efficiency.
- N 12.6.5.5.3** If any analytical anomaly that cannot be rationalized on the basis of the data set and other measurements is encountered for the analysis of a specific contaminant, discarding one contaminant from the calculation of the average cleaning efficiency shall be permitted.
- N 12.6.5.6\*** Alternative procedures for the analysis of specimens specified in 12.6.5.1 through 12.6.5.3 shall be permitted, provided that the procedures take the concentrations of the controls into account by providing sufficient sensitivity to allow for the measurement of a 1.0 percent difference or lower in cleaning efficiency.
- N 12.7 Heavy Metal Contaminated Specimen Preparation, Extraction, and Analysis.**
- N 12.7.1 Selection of Contaminants.**
- N 12.7.1.1** A certified solution shall be obtained that contains the following metals, each at a concentration of 100 ppm:
- (1) Antimony
  - (2) Arsenic
  - (3) Cadmium
  - (4) Chromium
  - (5) Cobalt
  - (6) Lead
- N 12.7.1.2** Alternative techniques for preparing a mixture of the target heavy metal contaminants shall be permitted if it can be demonstrated that the heavy metal concentrations are 100 ppm  $\pm$  10 ppm.
- N 12.7.2 Procedures for Contamination of Specimens.**
- N 12.7.2.1** All handling of specimens and metal solutions shall be performed while wearing disposable gloves. Use of glassware for contamination or extraction shall not be permitted as the use of these items can lead to cross contamination.
- N 12.7.2.2** Outer shell fabric prepared as specified in 12.4.3.2 shall be cut into 25 mm  $\times$  50 mm (1 in.  $\times$  2 in.) specimens, and the weight of each specimen shall be recorded in grams to the nearest 0.001 g.
- N 12.7.2.3\*** Using tweezers, one specimen shall be horizontally placed on a wire rack or other suitable support structure that minimizes the contact of the bottom surface of the specimens with the table or counter service.
- N 12.7.2.4** A volume of 1.0 mL of a 100 ppm metals standard solution shall be pipetted onto each fabric specimen.
- N 12.7.2.4.1** The operator shall ensure that the specimen is at the bottom of the plastic tube and sufficiently wetted by the metals standard solution.
- N 12.7.2.4.2** A total volume of 500  $\mu$ L of the metals standard solution shall be pipetted and allowed to dry before pipetting the remaining 500  $\mu$ L.
- N 12.7.2.4.3\*** The operator shall ensure that all applied metals standard solution remains on the specimen.
- N 12.7.2.4.4** Contaminated specimens shall be permitted to be dried in an oven at 50°C  $\pm$  5°C for up to 60 minutes.
- N 12.7.2.5** The weight of the contaminated specimens shall be recorded in grams to the nearest 0.001 g.
- N 12.7.2.6** After the specimens have been allowed to fully dry, plastic tweezers shall be used to insert specimens into metal-free plastic tubes.
- N 12.7.2.7** The amount of standard solution on the specimen shall be verified using the following equation:
- $$\text{[12.7.2.7]} \quad \text{amount of standard solution applied } (\mu\text{g}) = \frac{[\text{final specimen weight (g)} - \text{initial specimen weight (g)}] \times 1000}{\text{g}}$$
- N 12.7.3 Extraction of Specimens.**
- N 12.7.3.1 Acid Digestion.**
- N 12.7.3.1.1** Each specimen shall be added to an individual PFA microwave reaction vessel.
- N 12.7.3.1.2** A volume of 10 mL ( $\frac{1}{3}$  oz) concentrated nitric acid, approximately 70 percent weight/volume, shall be added to each PFA reaction vessel.
- N 12.7.3.1.3** Each PFA reaction vessel shall be microwaved at 1600 W, 90 percent power, for 20 minute at 170°C (338°F) and held for 30 minutes for a total 50-minute cycle.
- N 12.7.3.1.4** The specimens in the PFA reaction vessels shall be allowed to cool for approximately 30 minutes.
- N 12.7.3.1.5\*** Modifications to the specimen acid digestion procedures provided in 12.7.3.1.1 through 12.7.3.1.4 shall be permitted, provided that extraction recovery average efficiencies of 90 percent or better can be demonstrated.
- N 12.7.3.2 Filtration.**
- N 12.7.3.2.1** The gravitation filtration system shall be set up using a grade 40 quantitative ashless (0.007 percent ash maximum) filter paper and plastic beakers for the filter solution.
- N 12.7.3.2.2** The PFA microwave reaction vessel shall be carefully opened in the vent hood away from lab technicians due to the potential release of nitric acid fumes.
- N 12.7.3.2.3** A volume of 10 mL ( $\frac{1}{3}$  oz) deionized water shall be added to the microwave reaction vessel and the reaction vessel shall be turned over three times.
- N 12.7.3.2.3.1** The reaction vessel shall be permitted to “breathe” if needed by opening the lid to off-gas.
- N 12.7.3.2.4** Deionized water and the acid-digested sample mixture shall be poured into the filter setup.
- N 12.7.3.2.5** The addition of deionized water shall be repeated to microwave reaction vessel two more times, for a total of 30 mL deionized water rinsed through microwave reaction vessel.

**N 12.7.3.2.6** The resulting solution shall be filtered thoroughly once, then a second time, rinsing the filter paper with a small amount (<5 mL) of deionized water both times.

**N 12.7.3.2.7** Each sample solution shall be brought to a volume of 40 mL (1.35 oz) volume using deionized water.

**N 12.7.3.2.8** The sample solution shall be vortexed.

**N 12.7.3.2.9\*** Modifications to the specimen filtration procedures provided in 12.7.3.2.3.1 through 12.7.3.2.8 shall be permitted, provided that extraction recovery average efficiencies of 80 percent or better can be demonstrated.

### **N 12.7.3.3 Instrument Sample Preparation.**

**N 12.7.3.3.1** An internal standard shall be prepared in a 100 mL (3.38 oz) volumetric flask to receive 10 ppb using the following constituents:

- (1) 2 percent nitric acid
- (2) 0.2 mL of 100 ppm Ga
- (3) 0.2 mL of 100 ppm In
- (4) 0.2 mL of 100 ppm La

**N 12.7.3.3.2** A 1 mL volume of the extracted sample and a 25 µL volume of the internal standard shall be added to a 10 mL volumetric flask and diluted to volume with 2 percent nitric acid, and the resultant sample shall be vortexed.

**N 12.7.3.3.3** A 10 mL (½ oz) sample of each instrument calibration standard shall be prepared at the following concentrations using 2 percent nitric acid to bring volume to 10 mL (½ oz):

- (1) 0 ppb (to serve as blank)
- (2) 100 ppb
- (3) 1 ppm
- (4) 10 ppm
- (5) 100 ppm

**N 12.7.3.3.4** The internal standard shall be added.

**N 12.7.3.3.4.1** Once the test method recovery is established, the use of the internal standard shall be permitted to be optional.

**N 12.7.3.3.5** All samples shall be vortexed.

**N 12.7.3.3.6** Alternative sample preparation up procedures in lieu of 12.7.3.3.2 and 12.7.3.3.3 shall be permitted if a suitable scheme for demonstrating calibration of the respective metals achieved a linear correlation coefficient of 0.90 or better.

### **N 12.7.4 Analysis of Specimens.**

#### **N 12.7.4.1 Instrumentation Set-Up.**

**N 12.7.4.1.1** An inductively coupled plasma-mass spectrometer (ICP-MS) shall be prepared using the following method parameters to include those metals of interest:

- (1) Sweeps/readings: 20
- (2) Readings/replicates: 1
- (3) Number of replicates: 3
- (4) Dwell time: 50.0 ms
- (5) Mode: KED
- (6) RPq: 0.25
- (7) Detector mode: Dual
- (8) Measurement units: Counts
- (9) Automatic lens: On
- (10) Spectral peak processing: Sum
- (11) Signal profile processing
- (12) Baseline readings: 0

(13) Smoothing: Yes, Factor 5

**N 12.7.4.1.2** The blank, all samples, and instrument calibration standards shall be run on ICP-MS.

**N 12.7.4.1.3\*** An alternative analytical technique shall be permitted if it demonstrates sensitivity to the respective metals to a minimum of 100 ppb, provides for a linear calibration for determining each metal concentration with a correlation coefficient of 0.90 or better, and permits the ability for discerning a difference of 1.0 percent or lower in cleaning efficiency.

#### **N 12.7.4.2 Data Analysis.**

**N 12.7.4.2.1** The slope, intercept, and regression coefficient shall be calculated using standard metal solutions (0 ppb–100 ppm).

**N 12.7.4.2.2** The calculated slope and intercept shall be used to calculate the concentration of each individual metal each digested fabric swatch (ppb) in the 10 mL vial described in 12.7.3.3.1 using the following equation:

$$\text{metal concentration (ppb)} = \frac{\text{metal ion counts} - \text{metal ion intercept}}{\text{metal ion slope}} \quad [12.7.4.2.2]$$

**N 12.7.4.2.3** The calculated concentration in ppb shall be used to calculate the mass in µg of each metal in the original 40 mL vial described in 12.7.3.3.3.

**N 12.7.4.2.3.1** A correction factor of 0.401 shall be used as calculated by the two dilution factors in the following equation:

$$0.010025 \text{ L} \times 0.040 \text{ L} = 0.000401 \text{ L} \quad [12.7.4.2.3.1]$$

**N 12.7.4.2.4** The blank and blank specimen from each contaminated specimens shall be subtracted.

**N 12.7.4.2.5** The cleaning efficiency shall be calculated using the following equation:

$$\text{cleaning efficiency} = \frac{\mu\text{g metals}_i - \mu\text{g metals}_f}{\mu\text{g metals}_i} \times 100 \text{ percent} \quad [12.7.4.2.5]$$

**N 12.7.4.2.5.1** If any cleaning efficiencies are indicated as being above 100 percent, a cleaning efficiency of 100 percent shall be reported.

**N 12.7.4.2.5.2** If any cleaning efficiencies are indicated as being below 0 percent, a cleaning efficiency of 0 percent shall be reported.

**N 12.7.4.2.5.3** If any analytical anomaly that cannot be rationalized on the basis of the data set and other measurements is encountered for the analysis of a specific contaminant, discarding one contaminant from being reported and interpreted for the determination of heavy metal cleaning efficiencies shall be permitted.

**N 12.7.4.2.6** The percent recovery shall be calculated using the following equation:

$$\frac{\mu\text{g extracted}}{\mu\text{g deposited onto individual fabric swatch}} \times 100 \text{ percent} \quad [12.7.4.2.6]$$

**N 12.8 Bacterial Contaminated Specimen Preparation, Extraction, and Analysis.**

**N 12.8.1 Preparation of Test Microorganisms.**

**N 12.8.1.1** Testing shall be performed in accordance with Section 9 of ASTM E2274, *Standard Test Method for Evaluation of Laundry Sanitizers and Disinfectants*, with the following modifications:

- (1) The test microorganisms shall be *Klebsiella pneumoniae* (ATCC 4352) and *Staphylococcus aureus* (ATCC 6538).
- (2) A soil load shall not be added to the inoculum.

**N 12.8.1.2\*** Modifications in the procedures for the preparation of test microorganisms shall be permitted if the laboratory can demonstrate viability of alternate procedures used to prepare cultures for both *Klebsiella pneumoniae* (ATCC 4352) and *Staphylococcus aureus* (ATCC 6538) to be used in the contamination step specified in 12.8.2.

**N 12.8.2 Procedures for Contamination of Specimens.**

**N 12.8.2.1** All handling of specimens and metal solutions shall be performed while wearing disposable gloves.

**N 12.8.2.2** Outer shell fabric prepared as specified in 12.5.3.2 shall be cut into 25 mm × 38 mm (1 in. × 1.5 in.) specimens.

**N 12.8.2.2.1** An additional outer shell specimen shall be prepared as specified in 12.8.2.2 for the verification of the sterilization process specified in 12.8.2.3 and subjected to suitable sterilization assurance procedures.

**N 12.8.2.3** The outer shell specimens shall be wrapped in aluminum protective foil and autoclaved for 90 minutes at 121°C (250°F).

**N 12.8.2.4** Each specimen to be contaminated shall be inoculated with 0.03 mL of the prepared inoculum for the respective type of bacteria by dispersing the inoculum in such a way that covers as much of the specimen area as possible.

**N 12.8.2.4.1** Individual specimens shall be inoculated with only one type of bacteria.

**N 12.8.2.5** The contaminated specimens shall be placed in an individual petri dish and incubated at 37°C (98.6°F) for 30 minutes.

**N 12.8.2.6** Following incubation, the specimen shall be kept in a refrigerator at 4°C (39°F) until ready for shipping.

**N 12.8.2.7\*** Modifications to the procedures in 12.8.2.1 and 12.8.2.2 for the contamination of specimens shall be permitted if the laboratory can demonstrate consistency of bacterial counts as part of alternative procedures in the preparation of contaminated specimens for each bacterium.

**N 12.8.3 Analysis of Specimens for Bacterial Contamination.**

**N 12.8.3.1** Specimens shall be analyzed for bacterial contamination in accordance with Sections 12.12, 13, and 15 of ASTM

E2274, *Standard Test Method for Evaluation of Laundry Sanitizers and Disinfectants*, with the following modifications:

- (1) A 5-hour threshold shall be used to calculate the initial concentration of viable bacterial cells attached to the specimen that could not be estimated at the initial inoculation.
- (2) A polymerase chain reaction (PCR) detection method shall be permitted to be used to identify and quantify the levels of microorganisms present on the test specimens.
- (3) Viable bacterial levels shall be determined by colony-counting techniques for establishing the number of colony forming units (CFU).
- (4) A minimum average of  $1.0 \times 10^3$  CFU/specimen shall be able to be recovered for a valid test.

**N 12.8.3.2** The  $\log_{10}$  reduction shall be determined using the following steps:

- (1) The average bacterial count for contaminated specimens that were subjected to sanitization will be determined separately for each bacterium and shall be converted to a  $\log_{10}$  value.
- (2) The bacterial count for the contaminated, traveling specimen shall be converted to a  $\log_{10}$  value.
- (3) The  $\log_{10}$  reduction shall be calculated using the equation below:

[12.8.3.2]

$$\log_{10} \text{ reduction} = \log_{10} (\text{contaminated, traveling}) - \log_{10} (\text{average contaminated, sanitized})$$

- (4) The  $\log_{10}$  value for the bacterial count of the contaminated, control specimens shall be permitted to be used in place of the contaminated, travel specimen, subject to the requirement in 12.5.4.4.1 (1).

**N 12.8.3.3** Other control specimens including the noncontaminated specimens shall be used to assess the viability of the procedures and the potential for cross-contamination with foreign bacteria as needed to determine  $\log_{10}$  reduction due to the application of sanitization procedures.

**N 12.8.3.4\*** Modifications to the analysis procedures provided in 12.8.3.1 through 12.8.3.3 shall be permitted if the alternative methods are able to achieve viable bacterial counts in specimens subjected to the sanitization process for determination of  $\log_{10}$  reductions for the "sanitized" contaminated specimens as compared to the contaminated, traveling specimens.

**N 12.9 Preparation and Handling of Contaminated Specimens and Surrogate Clothing.**

**N 12.9.1 Preparation of Surrogate Garments.**

**N 12.9.1.1** Surrogate garment outer shells shall be made from an undyed 60 percent para-aramid/40 percent polybenzimidazole (PBI) base fabric with a reinforcement grid meeting the following specifications:

- (1) The outer shell fabric shall have a unit area weight of 240 g/m<sup>2</sup> to 268 g/m<sup>2</sup> (7.1 oz/yd<sup>2</sup> to 7.9 oz/yd<sup>2</sup>).
- (2) The outer shell fabric shall have a thickness of 0.584 mm ± 0.254 mm (0.023 in. ± 0.10 in.).
- (3) The outer shell fabric shall have a water absorption resistance of less than 5 percent when tested in pristine condition in accordance with Section 8.25 of NFPA 1971.

**N 12.9.1.2** Fabric used for the creation of the sample mesh pockets on each garment shall be an aramid-based, warp-knit, mesh-style fabric having an open area of 20 to 40 percent and a unit area weight ranging from 220 g/m<sup>2</sup> to 270 g/m<sup>2</sup> (6.5 oz/yd<sup>2</sup> to 8.0 oz/yd<sup>2</sup>).

**N 12.9.1.3** Surrogate garments shall consist of a surrogate coat and surrogate pants.

**N 12.9.1.4** Surrogate coats shall be made from a single layer of outer shell fabric using appropriate seams, finished edges, and mesh pockets with thread that complies with the respective requirements of NFPA 1971, and shall be fabricated as shown in Figure 12.9.1.4 with the following additional specifications:

- (1) Surrogate coats shall be prepared with a body width of 74 cm ± 5 cm (29 in. ± 2 in.) and a sleeve length of 47 cm ± 5 cm (18½ in. ± 2 in.) when measured from the top of coat seam to the end of the sleeve hem.
- (2) Surrogate coats shall not have front closures, collars, coat sleeve end reinforcements, hardware, or any other materials not specified in this section.
- (3) Each surrogate coat shall have a 254 mm × 254 mm (10 in. × 10 in.) outer shell pocket positioned on the front lower left side of the garment, approximately 50 mm (2 in.) from the bottom hem and 50 mm (2 in.) from the left side seam, that is secured using a double needle seam and has a top finished edge with a 152 mm (6 in.) strip of hook-and-loop closure to secure the top of the pocket.
- (4) Each surrogate coat shall have a 75 mm (3 in.) wide strip of reflective trim compliant with the respective requirements of NFPA 1971 sewn 75 mm (3 in.) above the bottom hem of the coat and on each sleeve at 75 mm (3 in.) above the bottom edge of the sleeve end.
- (5) Each surrogate coat shall have three 152 mm × 152 mm (6 in. × 6 in.) sample mesh pockets in accordance with the following requirements:
  - (a) The pockets shall be positioned on the front of the garment and numbered as indicated in Figure 12.9.1.4.
  - (b) One pocket shall be positioned on top right side (Pocket 1), a second pocket shall be positioned in the center inside of the lower left side pocket (Pocket 2), and a third pocket shall be positioned on the upper right sleeve (Pocket 3).
  - (c) The openings of all three pockets shall be oriented toward the top.
  - (d) The pockets shall include a 101 mm (4 in.) strip of 21 mm (0.8125 in.) hook-and-loop tape for securing the open end of the pocket.

**N 12.9.1.5** Surrogate pants shall be made from a single layer of outer shell fabric using appropriate seams, finished edges, and mesh pockets with thread that complies with the respective requirements of NFPA 1971, and shall be fabricated as shown in Figure 12.9.1.5 with the following additional specifications:

- (1) Surrogate pants shall be prepared with a 56 cm ± 5 cm (22 in. ± 2 in.) width at the garment waist and an inseam length of 76.2 cm ± 5.0 cm (30 in. ± 2 in.) as measured from the garment crotch to the bottom of the pant leg hem.
- (2) Surrogate pants shall not have fly closures, suspender hardware, pant hem reinforcements, other hardware, or any other materials not specified in this section.

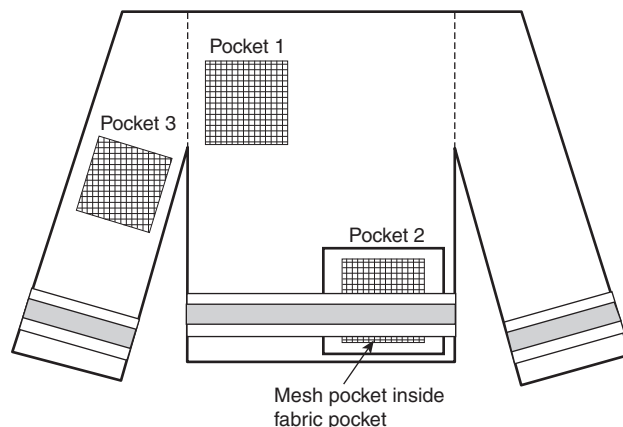

**N FIGURE 12.9.1.4** Design and Locations of Sample Mesh Pockets on Surrogate Coats.

- (3) Each surrogate pant shall have a 254 mm × 254 mm (10 in. × 10 in.) outer shell pocket positioned in the middle of the upper right leg of the garment that is secured using a double needle seam and has a top finished edge with a 152 mm (6 in.) strip of hook-and-loop closure to secure the top of the pocket.
- (4) Each surrogate pant shall have a 254 mm × 254 mm (10 in. × 10 in.) coated outer shell fabric reinforcement in the middle of left leg that is secured using a double needle seam and has a top finished edge with a 152 mm (6 in.) strip of hook-and-loop closure to secure the top of the reinforcement.
- (5) Each surrogate pant shall have a 75 mm (3 in.) wide strip of reflective trim compliant with the respective requirements of NFPA 1971 attached circumferentially around each lower leg of the garment at 75 mm (3 in.) above the bottom hem of the leg.
- (6) Each surrogate pant shall have three 152 mm × 152 mm (6 in. × 6 in.) sample mesh pockets in accordance with the following requirements:
  - (a) The pockets shall be positioned on the front of the garment.
  - (b) One pocket shall be positioned in the middle approximately 101 mm (4 in.) from the waistline (Pocket 1), a second pocket shall be centered inside of the right leg outer shell pocket (Pocket 2), and a third pocket shall be centered inside of the left knee reinforcement pocket (Pocket 3).
  - (c) The openings of all three pockets shall be oriented toward the top, as shown in Figure 12.9.1.5.
  - (d) The pockets shall include a 101 mm (4 in.) strip of 21 mm (0.8125 in.) hook-and-loop tape for securing the open end of the pocket.

**N 12.9.1.6** Surrogate garments shall be subjected to an advanced cleaning by the verification organization prior to use by the cleaning facility.

## **N 12.9.2** Preparation of Ballast Fabric-Based Wash Panels.

**N 12.9.2.1** Four different ballast fabric-based wash panels — Panel A, Panel B, Panel C, and Panel F — shall be prepared from the ballast materials specified in 12.4.4.3 according to the instructions provided in 12.9.2.2 through 12.9.2.5. All panel

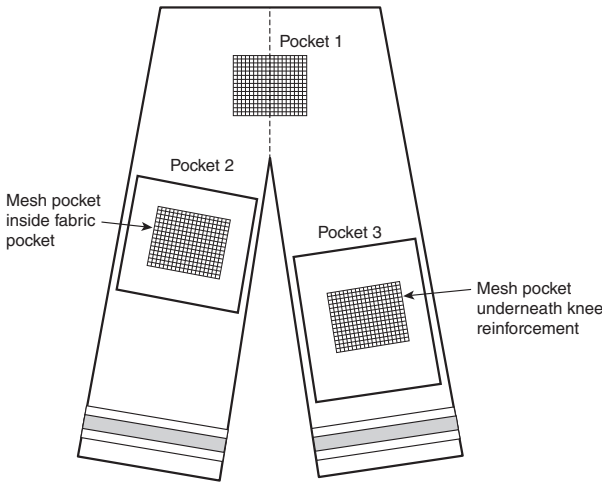

**N** FIGURE 12.9.1.5 Design and Locations of Sample Mesh Pockets on Surrogate Pants.

edges shall be unfinished. Panel D shall be the surrogate coat and Panel E shall be the surrogate pants prepared according to 12.9.1.

- N 12.9.2.2** Panel A shall be a 686 mm × 686 mm (27 in. × 27 in.) square with two 508 mm (20 in.) slits set 152 mm (6 in.) from each edge as shown in Figure 12.9.2.2.
- N 12.9.2.3** Panel B shall be a 686 mm × 1500 mm (27 in. × 59 in.) rectangle with two bisecting 560 mm (22 in.) slits originating from opposite sides on the shorter dimensions of the shape as shown in Figure 12.9.2.3.
- N 12.9.2.4** Panel C shall be a 686 mm × 1500 mm (27 in. × 59 in.) rectangle with two sets of two bisecting 560 mm (22 in.) slits originating from opposite sides on the shorter dimensions

of the shape, spaced at 229 mm (9 in.) intervals from each edge and from each other, as shown in Figure 12.9.2.4.

- N 12.9.2.5** Panel F shall be a total of three rectangular panels that measure 228 mm × 750 mm (9 in. × 29.5 in.) as shown in Figure 12.9.2.5.
- N 12.9.2.6** Panel D shall be depicted as shown in Figure 12.9.2.6.
- N 12.9.2.7** Panel E shall be depicted as shown in Figure 12.9.2.7.

**N 12.9.3 Preparation of Wash Load.**

- N 12.9.3.1** Panel A shall be folded and placed into the wash load as shown in Figure 12.9.3.1.
- N 12.9.3.2** Panel B shall be folded and placed into the wash load as shown in Figure 12.9.3.2.
- N 12.9.3.3** Panel C shall be folded and placed into the wash load as shown in Figure 12.9.3.3.
- N 12.9.3.4** Panel D shall be folded and placed into the wash load as shown in Figure 12.9.3.4.
- N 12.9.3.5** Panel E shall be folded and placed into the wash load as shown in Figure 12.9.3.5.
- N 12.9.3.6** Panel F shall be folded and placed into the wash load as shown in Figure 12.9.3.6.
- N 12.9.3.7** The panels shall be placed in the washer/extractor according to the sequence provided in Figure 12.9.3.7(a), starting at the bottom, and depicted in Figure 12.9.3.7(b) through Figure 12.9.3.7(f).

- N 12.9.3.7.1** It shall be permitted to place the wash load with all of the panels at a 90-degree angle with respect to their orientations shown in 12.9.3.7.

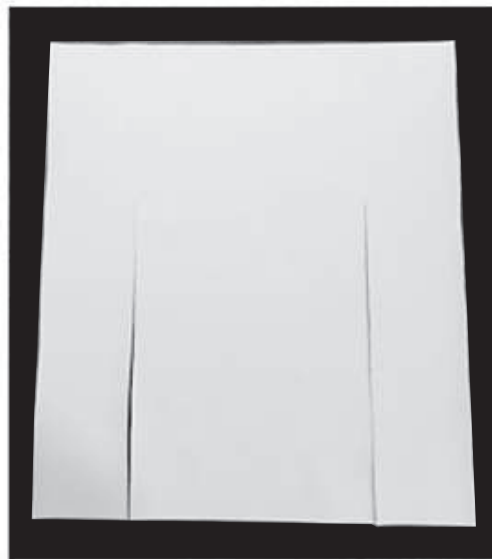
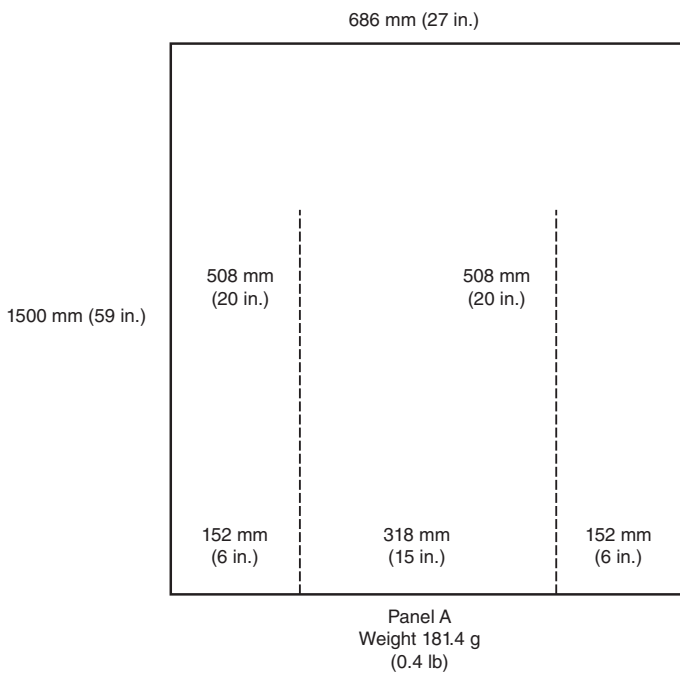

**N** FIGURE 12.9.2.2 Specifications and Photograph for Panel A.

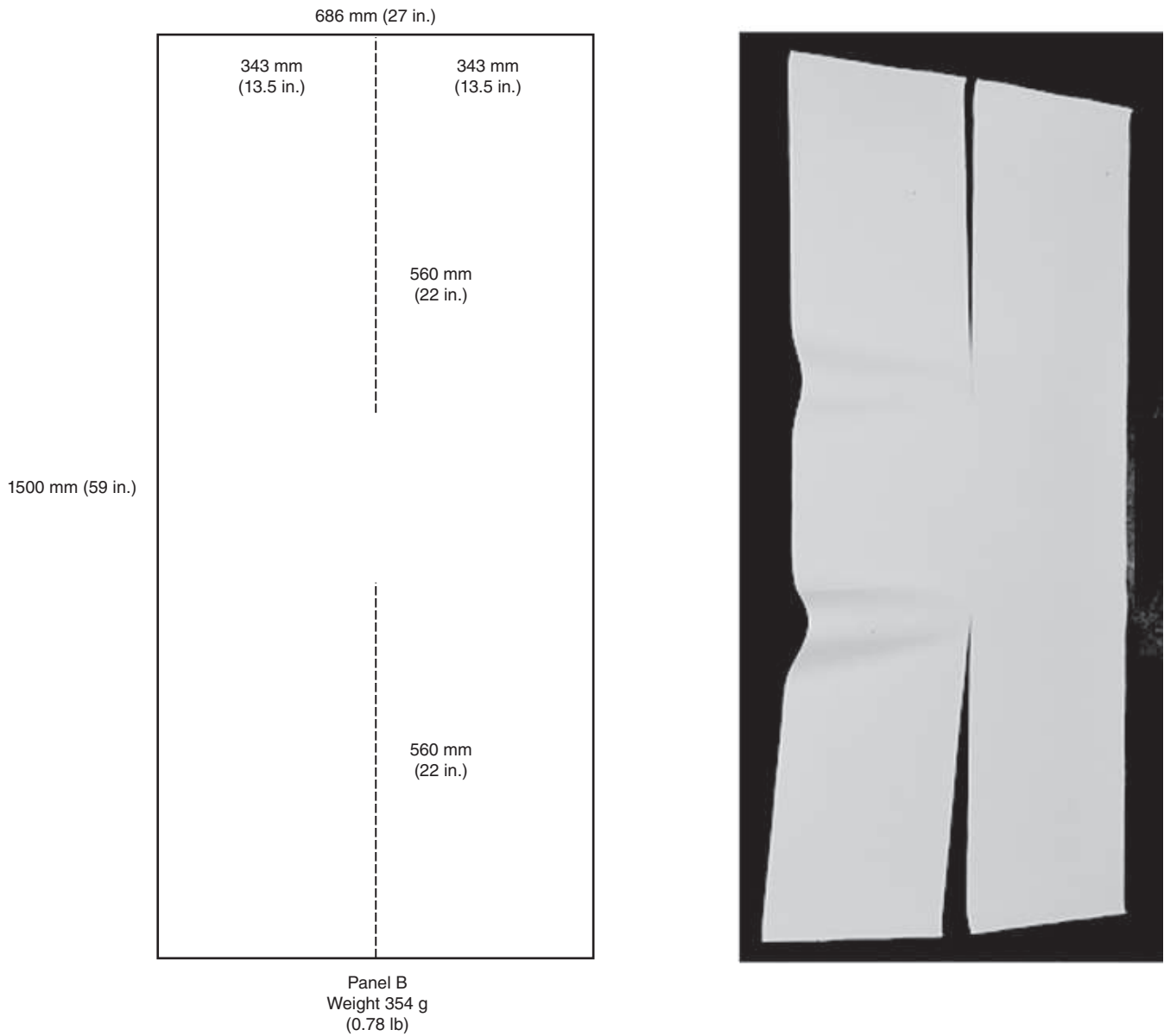

**N** FIGURE 12.9.2.3 Specifications and Photograph for Panel B.



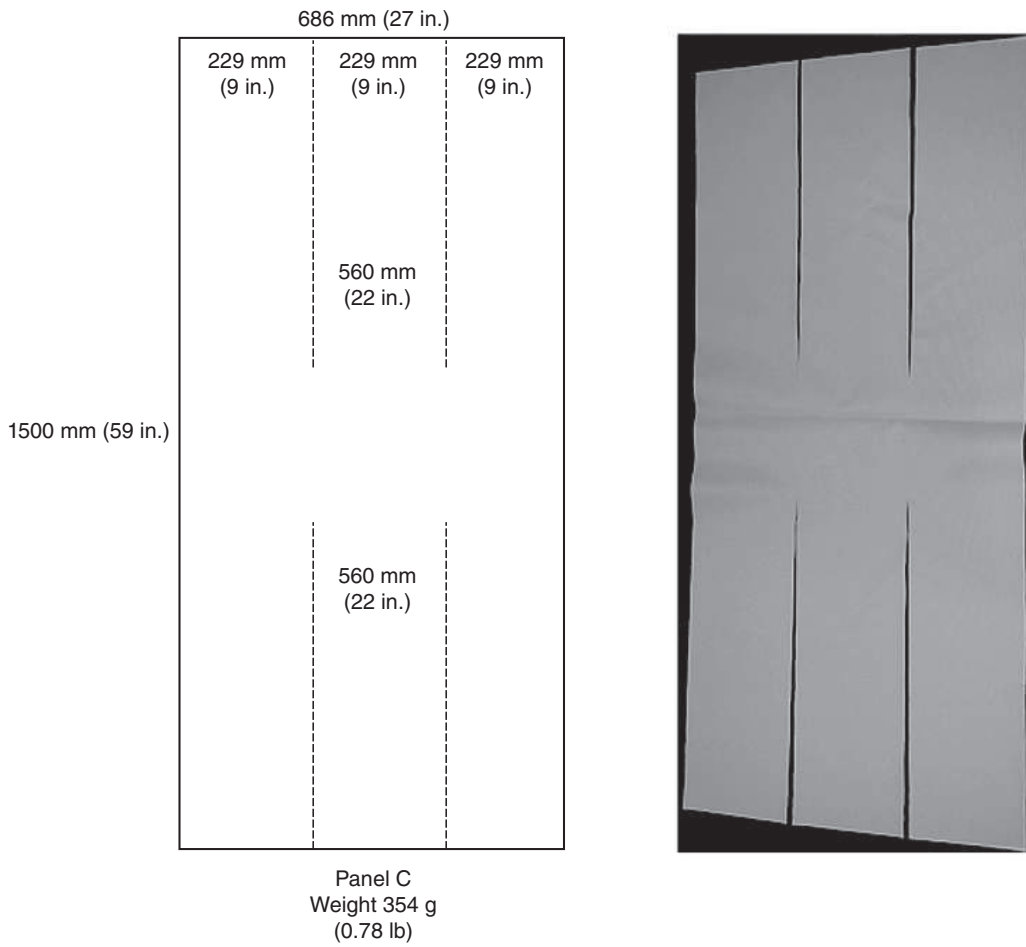

**N** FIGURE 12.9.2.4 Specifications and Photograph for Panel C.

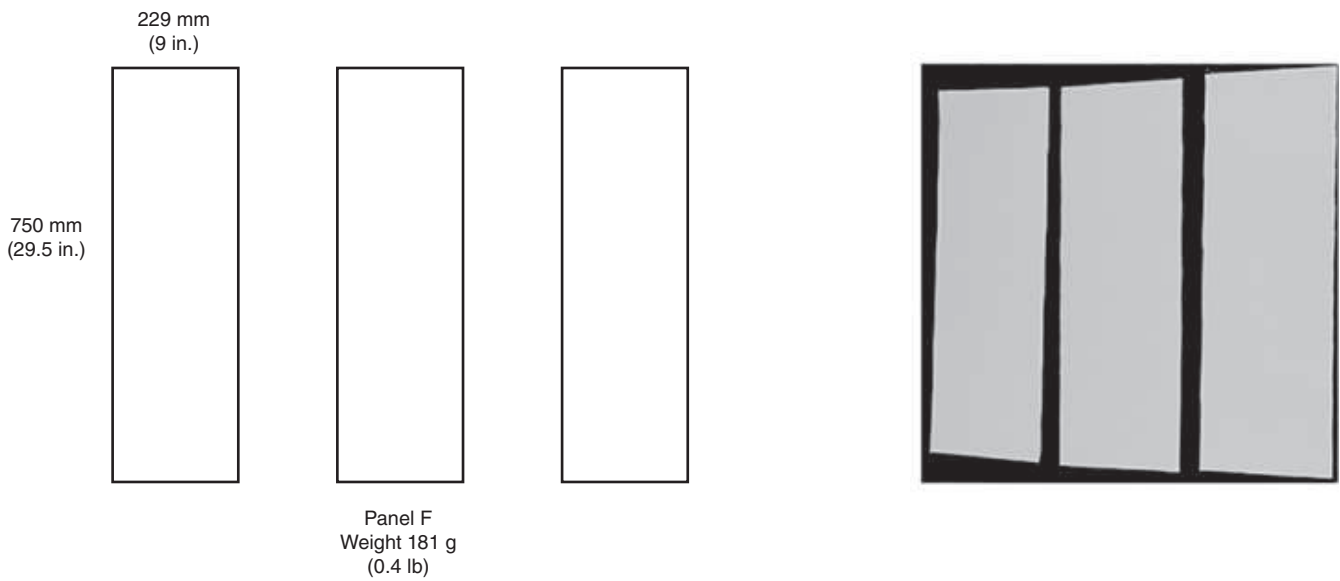

**N** FIGURE 12.9.2.5 Specifications and Photograph for Panel F.

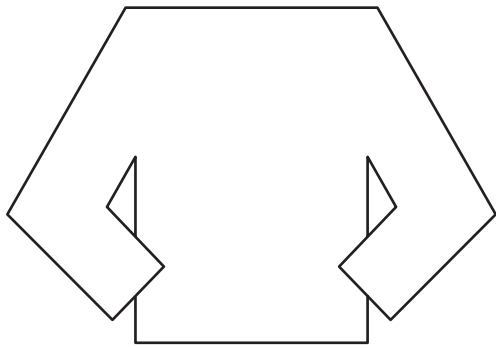

Panel D  
Weight 354 g  
(0.78 lb)



**N** FIGURE 12.9.2.6 Diagram and Photograph for Panel D.

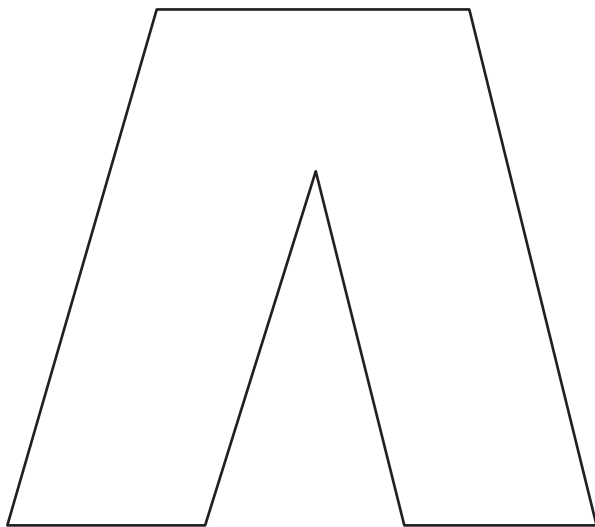

Panel E  
Weight 354 g  
(0.78 lb)



**N** FIGURE 12.9.2.7 Diagram and Photograph for Panel E.

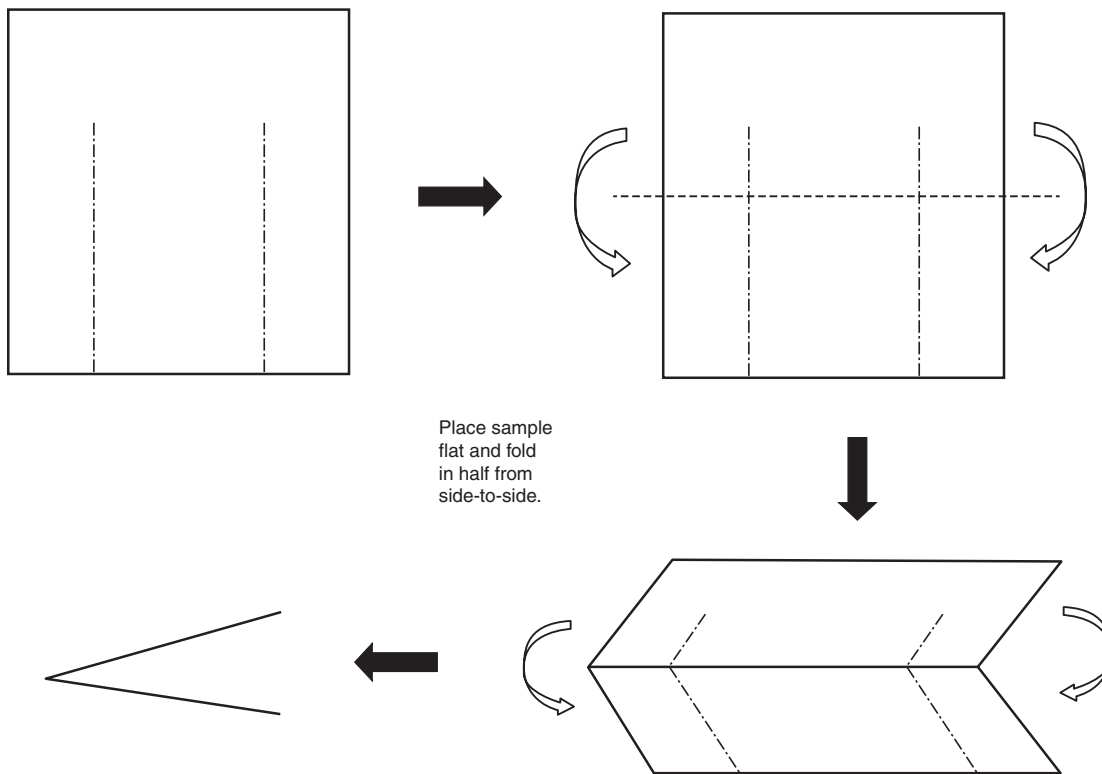

**N** FIGURE 12.9.3.1 Steps for Folding and Placing Panel A into Wash Load.

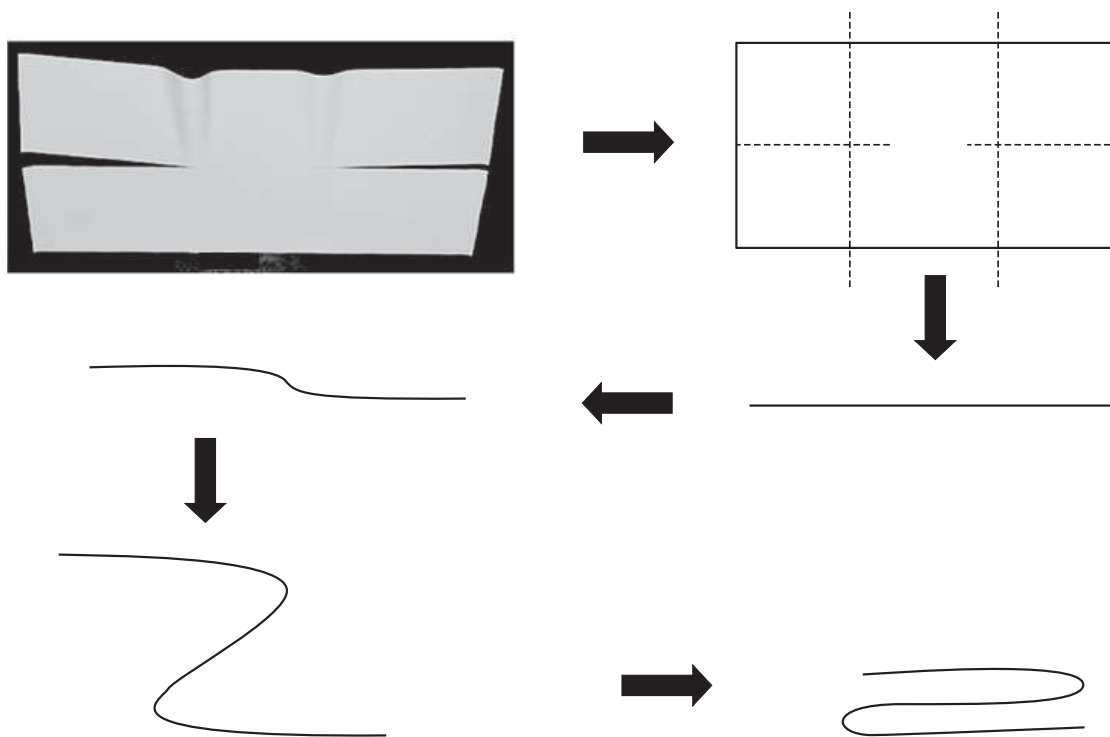

Note: Panel B is to be divided in thirds. Using these reference points, Panel B is to be grabbed at each line above and the left fold is to be pulled under the right fold until material is flat on itself.

**N** FIGURE 12.9.3.2 Steps for Folding and Placing Panel B into Wash Load.

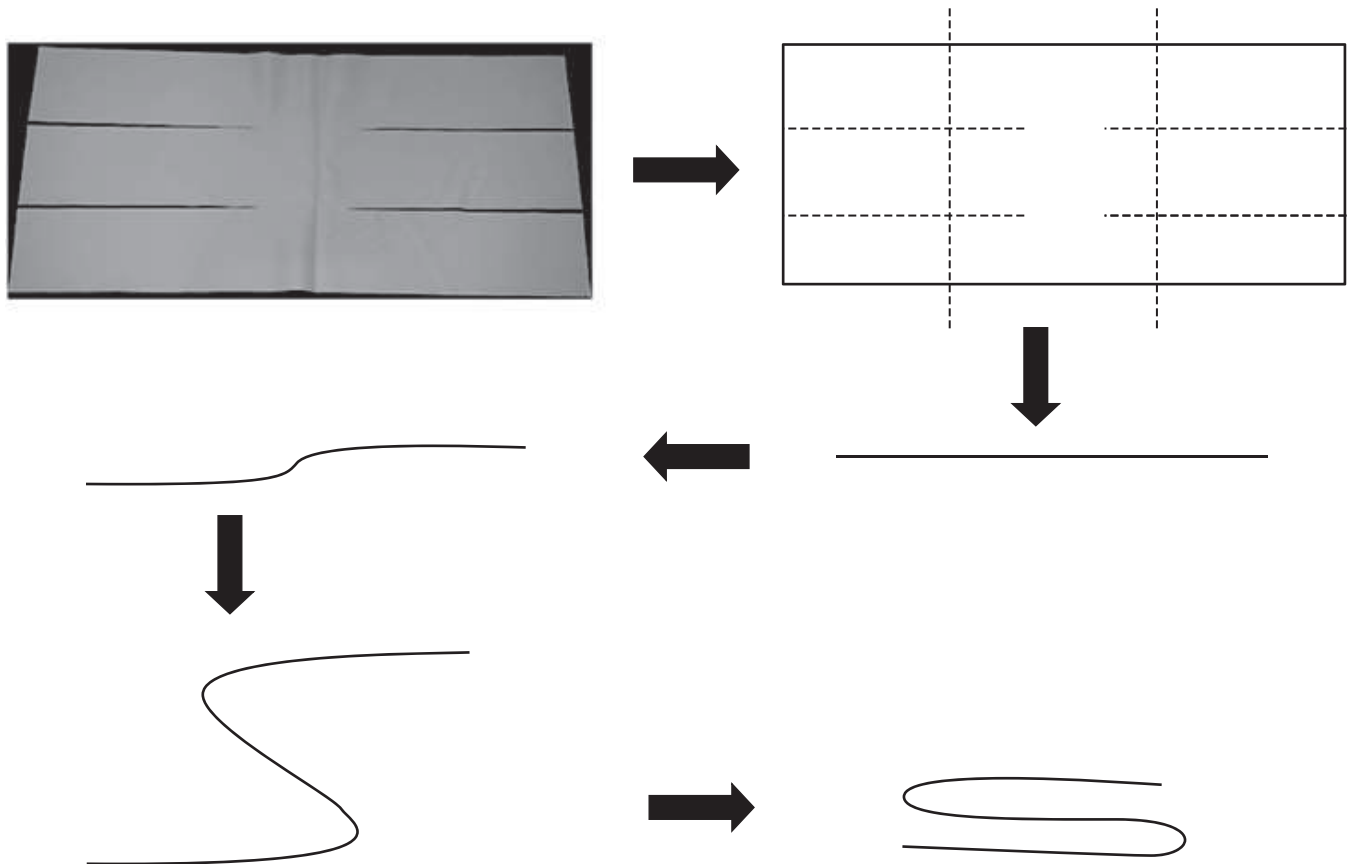

Note: The panel is to be divided in thirds. Using these reference points, Panel B is to be grabbed at each line above, and the right fold is to be pulled under the left fold until material is flat on itself.

**N** FIGURE 12.9.3.3 Steps for Folding and Placing Panel C into Wash Load.

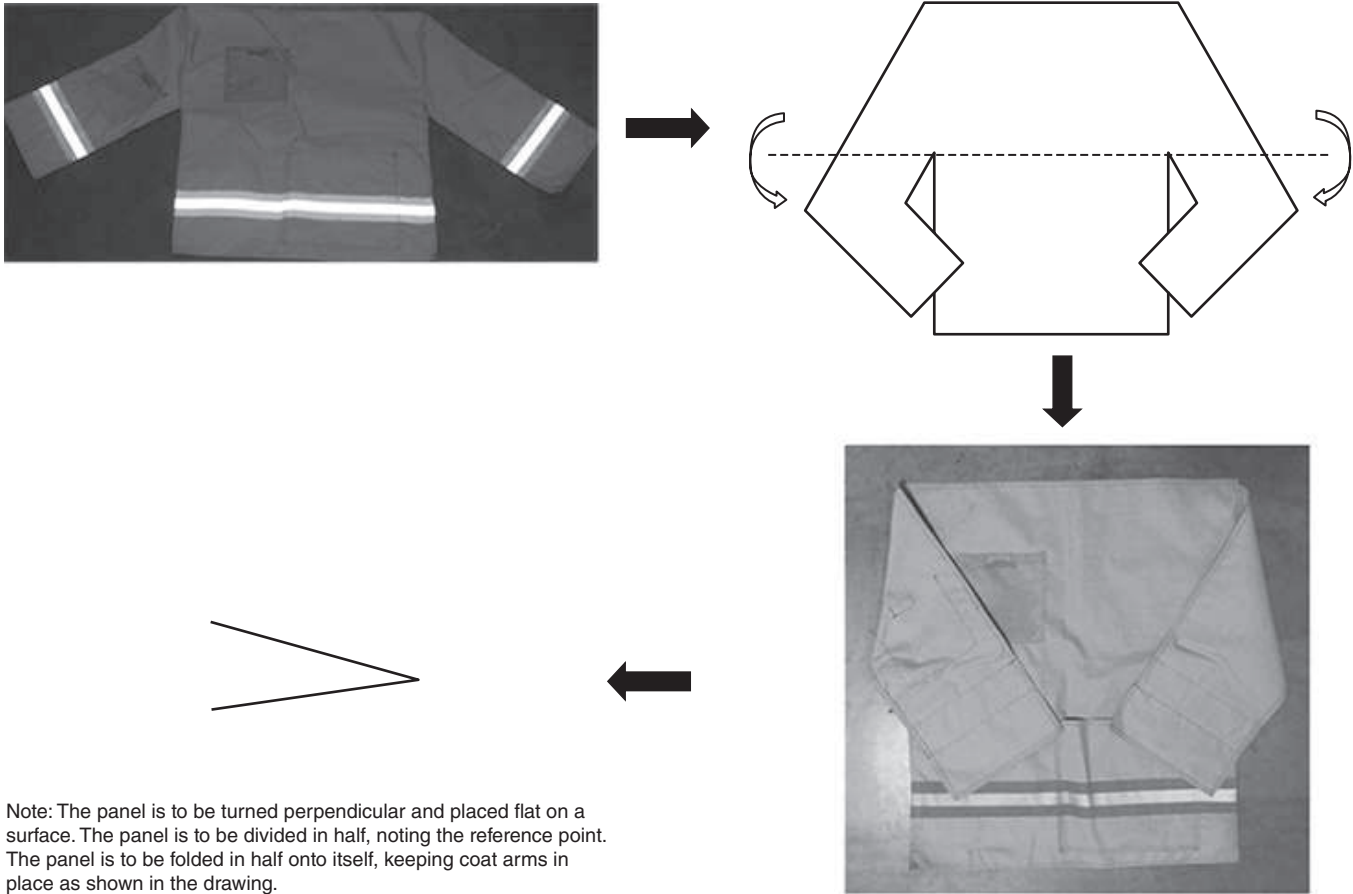

Note: The panel is to be turned perpendicular and placed flat on a surface. The panel is to be divided in half, noting the reference point. The panel is to be folded in half onto itself, keeping coat arms in place as shown in the drawing.

**N** FIGURE 12.9.3.4 Steps for Folding and Placing Panel D into Wash Load.

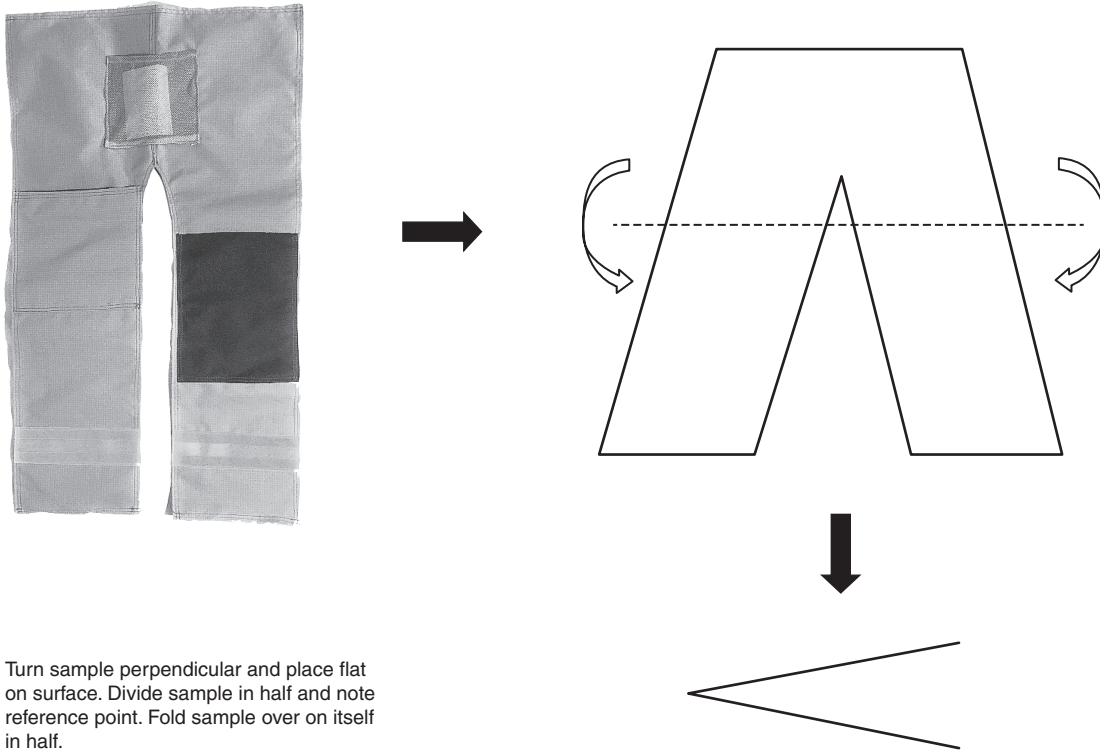

**N** FIGURE 12.9.3.5 Steps for Folding and Placing Panel E into Wash Load.

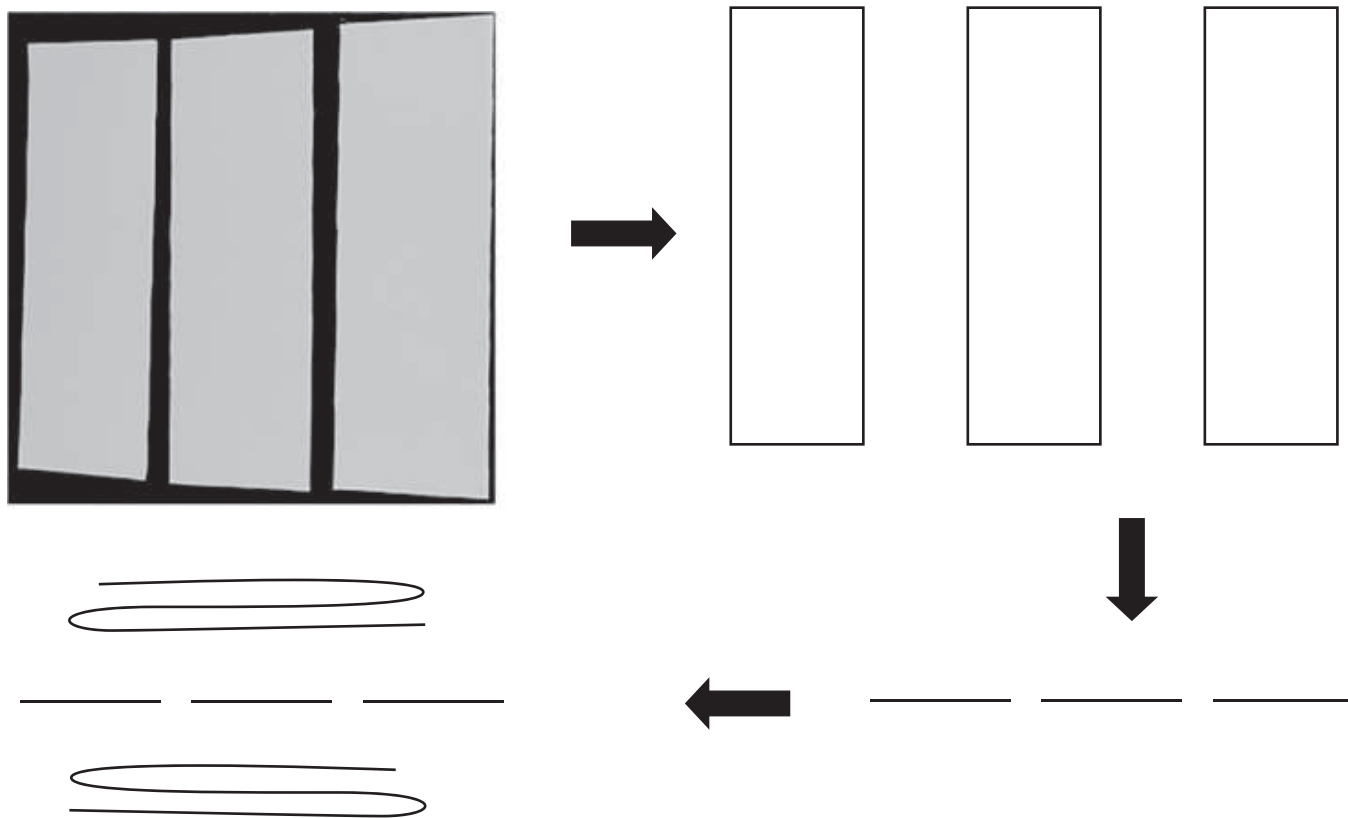

Note: The panels are to be laid flat and placed across the preceding ballast sample, oriented from front to back of the wash load.

**N** FIGURE 12.9.3.6 Steps for Folding and Placing Panel F into Wash Load.

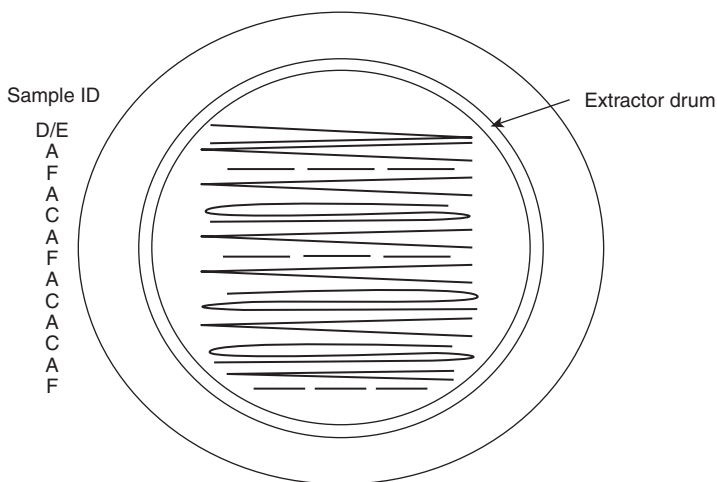

**N** FIGURE 12.9.3.7(a) Sequence for Placing Panels in Washer/Extractor Drum.



**N** FIGURE 12.9.3.7(b) Placement of Panel F (3 Pieces) into Washer/Extractor Drum.



**N** FIGURE 12.9.3.7(c) Placement of Panel C into Washer/Extractor Drum.





**N** FIGURE 12.9.3.7(d) Placement of Panel A into Washer/Extractor Drum.

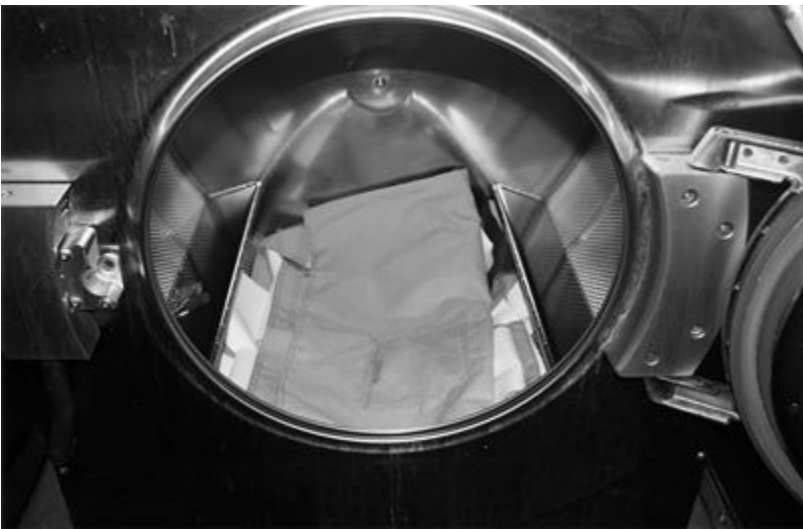

**N** FIGURE 12.9.3.7(e) Placement of Panel D into Washer/Extractor Drum.

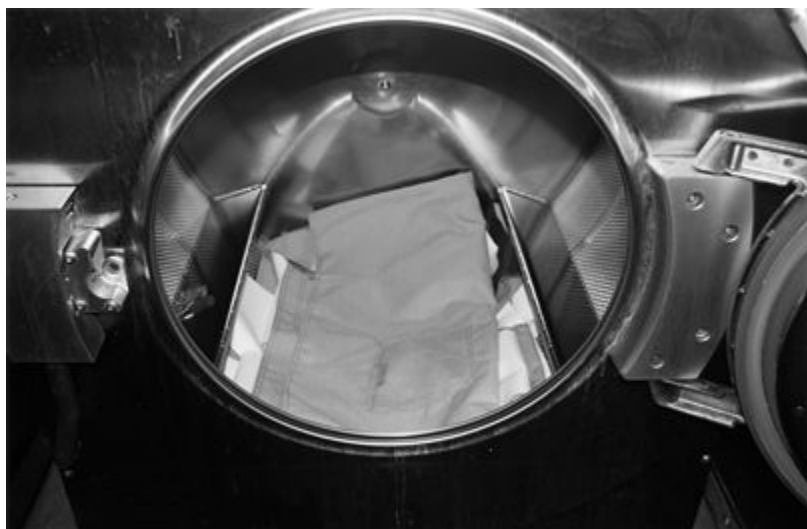

**N** FIGURE 12.9.3.7(f) Placement of Panel E into Washer/Extractor Drum.

**N 12.9.3.8\*** The sequencing of panels shall be as follows:

- (1) The sequencing shall be repeated for attaining a wash load with the mass capacity,  $\pm 5$  percent, as specified by the cleaning facility.
- (2) Panel D and Panel E shall be alternated in the sequencing.
- (3) A total of three panels each shall be used for Panel D and Panel E.
- (4) Panel D and Panel E shall alternatively be evenly distributed within the wash load so that there are a near equal number of nonsurrogate panels between each surrogate garments (Panel D or Panel E).
- (5) It shall be permissible to adjust the sequence of the panels to meet the requirements of 12.9.3.8(1) through 12.9.3.8(4) in order to attain the target wash load mass capacity.

**N 12.9.3.9\*** Adjustments to the use and sequencing of the panels is permitted to attain proper load capacity where the panels open during the cleaning process.

#### Annex A Explanatory Material

*Annex A is not a part of the requirements of this NFPA document but is included for informational purposes only. This annex contains explanatory material, numbered to correspond with the applicable text paragraphs.*

**A.3.2.1 Approved.** The National Fire Protection Association does not approve, inspect, or certify any installations, procedures, equipment, or materials; nor does it approve or evaluate testing laboratories. In determining the acceptability of installations, procedures, equipment, or materials, the authority having jurisdiction may base acceptance on compliance with NFPA or other appropriate standards. In the absence of such standards, said authority may require evidence of proper installation, procedure, or use. The authority having jurisdiction may also refer to the listings or labeling practices of an organization that is concerned with product evaluations and is thus in a position to determine compliance with appropriate standards for the current production of listed items.

**A.3.2.2 Authority Having Jurisdiction (AHJ).** The phrase “authority having jurisdiction,” or its acronym AHJ, is used in NFPA documents in a broad manner, since jurisdictions and approval agencies vary, as do their responsibilities. Where public safety is primary, the authority having jurisdiction may be a federal, state, local, or other regional department or individual such as a fire chief; fire marshal; chief of a fire prevention bureau, labor department, or health department; building official; electrical inspector; or others having statutory authority. For insurance purposes, an insurance inspection department, rating bureau, or other insurance company representative may be the authority having jurisdiction. In many circumstances, the property owner or his or her designated agent assumes the role of the authority having jurisdiction; at government installations, the commanding officer or departmental official may be the authority having jurisdiction.

**A.3.2.4 Listed.** The means for identifying listed equipment may vary for each organization concerned with product evaluation; some organizations do not recognize equipment as listed unless it is also labeled. The authority having jurisdiction should utilize the system employed by the listing organization to identify a listed product.

**N A.3.3.5 Carcinogen/Carcinogenic.** Lists of carcinogens can be found in the following sources:

- (1) U.S. National Toxicology Program (NTP): <https://ntp.niehs.nih.gov/pubhealth/roc/index-1.html#toc1>
- (2) International Agency for Research on Cancer (IARC): <http://monographs.iarc.fr/ENG/Classification/>
- (3) National Institute for Occupational Safety and Health (NIOSH): <https://www.cdc.gov/niosh/topics/cancer/npotocca.html>
- (4) American Conference of Governmental Industrial Hygienists (ACGIH): *2016 Threshold Limit Values (TLVs) and Biological Exposure Indices (BEIs)*

Each organization classifies specific substances or activities as being carcinogenic in different ways.

The products of combustion (smoke and fire gases) at a typical residential structural fire are a common source of carcinogens for fire fighters. As of 2007, IARC has classified

occupational exposure as a fire fighter as a Class 2B carcinogen (possibly carcinogenic to humans).

**A.3.3.8 CBRN Terrorism Agents.** Chemical terrorism agents include solid, liquid, and gaseous chemical warfare agents and toxic industrial chemicals. Chemical warfare agents include, but are not limited, to GB (Sarin), GD (Soman), HD (sulfur mustard), VX, and specific toxic industrial chemicals. Many toxic industrial chemicals (e.g., chlorine and ammonia) are identified as potential chemical terrorism agents because of their availability and the degree of injury they could inflict.

Biological terrorism agents are bacteria, viruses, or toxins derived from biological material. The CBRN ensemble protects against biological particles dispersed as aerosols and liquid-borne pathogens. Airborne biological terrorism agents could be dispersed in the form of liquid aerosols or solid aerosols (e.g., a powder of bacterial spores). Liquid-borne pathogens could be encountered during a terrorism incident as a result of deliberate disposal or from body fluids released by victims of other weapons (e.g., explosives, firearms).

CBRN ensembles protect from radiological particulates dispersed as aerosols. The protection is defined for blocking or filtering airborne particulate matter and liquid and solid aerosols but not for radiological gases or vapors. Airborne particulates have the ability to emit alpha and beta particles and ionizing radiation from the decay of unstable isotopes.

**N A.3.3.12 Cleaning.** Cleaning is considered separate from the use of disinfectants and sanitizers; however, some cleaning processes might also effectively remove biological contamination. Removal of biological contamination is covered under disinfection and sanitization (*see Section 7.4*).

**A.3.3.12.1 Advanced Cleaning.** Advanced cleaning usually requires that ensemble elements be temporarily taken out of service. Examples include hand washing and machine washing, depending on the type of protective element involved. It should be noted that advanced cleaning might not remove all contaminants.

**A.3.3.12.2 Specialized Cleaning.** This level of cleaning involves specific procedures and specialized cleaning agents and processes primarily for the removal of hazardous materials such as bulk chemicals and other designated substances but excluding disinfection or sanitization of microbial contamination. Different approaches can be used for removing specific types of contamination. Specialized cleaning can also be an enhanced form of advanced cleaning.

**N A.3.3.13 Cleaning Facility.** This term is used within the standard to collectively refer to any facility that can be subject to verification for advanced cleaning, sanitization, or both.

**N A.3.3.15 Contamination.** Ensembles and ensemble elements can be exposed to products of combustion and other hazardous materials in several ways through contact with gases/vapors, liquids, or particulates. A fire in which the fire fighter wears SCBA and is exposed to fire smoke, other particulates, and fire gases represents a common source of contamination.

The extent and persistency of the contamination in the ensemble or ensemble element will vary with the type of contaminant, the length of the contamination period, and the means by which the ensemble or ensemble elements are contaminated. In general, contamination that is persistent represents the greatest concern since these forms of contaminants

might remain in the clothing for extended periods of time and provide continued exposure to the fire fighter.

Examples of common contaminants found in fires include, but are not limited to, the following:

- (1) Heavy inorganic metals (e.g., arsenic, antimony, cadmium, chromium, mercury)
- (2) Semi-volatile organic compounds, including but not limited to, the following:
  - (a) Polynuclear aromatic hydrocarbons (PAHs) (e.g., anthracene, chrysene, fluoranthene, naphthalene, pyrene)
  - (b) Phthalate plasticizers [e.g., benzyl butyl phthalate (BPP), bis(2-ethylhexyl) phthalate (DEHP), dimethyl phthalate]
  - (c) Polybrominated diphenyl ether flame retardants (PBDEs) [e.g., pentabromodiphenyl ether (BDE 99), hexabromodiphenyl ether (BDE 153)]
  - (d) Polychlorinated biphenyls (PCBs) (e.g., 2,2,3,3,4,4,5,5-Octachlorobiphenyl)
  - (e) Substituted phenols (e.g., 2-methylphenol and pentachlorophenol)
- (3) Hazardous particulates (e.g., soot, asbestos, silica, lead dust)

In contrast, many volatile organic chemicals such as formaldehyde and benzene, while hazardous, easily evaporate unless bound in the materials used in the element. In addition, carbon particles that make up the majority of smoke actually absorb and hold many products of combustion, resulting in persistent contamination.

Certain materials, components, or portions of an ensemble element or ensemble might be more susceptible to contamination. For example, the textile fabric components of a protective helmet might be more easily contaminated than the hard surface of the helmet shell.

**N A.3.3.21 Decontamination.** Decontamination is specific to the removal or neutralization of contamination whereas cleaning can remove both soiling and contamination. Decontamination might also apply to certain types of specialized cleaning where particular procedures are used to remove or neutralize contaminants other than products of combustion that are found on protective ensembles or elements.

Decontamination might involve mechanical, chemical, thermal, or combined processes for removing or neutralizing contaminants. An example of a mechanical process is where brushing or wiping removes an exterior contaminant from the surface of the element. Chemical processes involve the use of detergents or other cleaning agents that react with or aid in the removal of contaminants from element materials. Heating is one type of a thermal process where higher temperatures could cause certain contaminants to evaporate out of the element materials. Laundering is a form of a combined process where the machine agitation, use of a detergent, and heated water all work together to remove contaminants from the element.

**N A.3.3.22 Disinfectant.** Disinfectants as an antimicrobial agent are considered a pesticide and thus subject to regulations established by the U.S. Environmental Protection Agency (EPA). All disinfectants must be registered with the EPA and meet specific labeling requirements. A listing of currently registered disinfectants can be found at [www.epa.gov/pesticide-registration/selected-epa-registered-disinfectants](http://www.epa.gov/pesticide-registration/selected-epa-registered-disinfectants).

Disinfectants are required to be used as specified on the product label as determined by the EPA registration process.

Disinfectants can either be used on hard surfaces such as helmet shells and eye and face protection devices, or be used as a presoak treatment for fabrics and textiles. Appropriately labeled and registered disinfectants can also be used for disinfecting laundry. The specific requirements for demonstrating acceptable performance are found in the following EPA Office of Chemical Safety and Pollution Prevention (OCSPP) product performance test guidelines:

- (1) OCSPP 810.2200, “Disinfectants for Use on Hard Surfaces — Efficacy Data Recommendations”
- (2) OCSPP 810.2400, “Disinfectants and Sanitizers for Use on Fabrics and Textiles — Efficacy Data Recommendations”

Both of these documents provide for different classifications of disinfectants for their intended use. Classification types include limited (primarily for household use), general or broad spectrum (used in commercial areas), and hospital or health care. Specific procedures and target microorganisms are utilized to demonstrate the effectiveness of the respective disinfectant. In general, a disinfectant must kill all target microorganisms.

See A.7.4.3 for more information on registered disinfectants.

**A.3.3.23 Drag Rescue Device.** The drag rescue device (DRD) is intended solely to assist in pulling or dragging an incapacitated fire fighter and is not intended for vertical rescue operations where the victim fire fighter would be raised or lowered.

**A.3.3.29 Emergency Medical Operations.** Patient care includes, but is not limited to, first aid, cardiopulmonary resuscitation, basic life support, and advanced life support.

**A.3.3.32 Ensemble Elements.** The proximity fire fighting protective ensemble includes, but is not limited to, garments, helmets, shrouds, gloves, and footwear. The structural fire fighting protective ensemble includes, but is not limited to, garments, helmets, hoods, gloves, and footwear.

**A.3.3.36 Flame Resistance (Protective Clothing and Equipment).** Flame resistance can be an inherent property of the textile material, or it can be imparted by specific treatment.

**A.3.3.43 Goggles.** To provide primary protection, goggles must be certified to ANSI/ASSE Z87.1, *Occupational and Educational Personal Eye and Face Protection Devices*.

**N A.3.3.44 Gross Decontamination.** In this standard, the term *preliminary exposure reduction* is used in lieu of the more common industry term *gross decontamination* because it more accurately describes the activities specified by NFPA 1851 for initially addressing contaminated fire-fighting protective ensembles and ensemble elements. It is understood that while preliminary exposure reduction is likely to remove some contamination from the surface of the protective ensemble or ensemble elements, it does not guarantee full cleaning or decontamination for the removal of all contaminants. The use of the term *preliminary exposure reduction* reduces the possible inference that gross decontamination might be the only activity needed to render clothing safe for reuse and free from contamination. In hazardous materials operations, the types of protective clothing might be better designed to resist contamination and allow for easily cleaning given the clothing design and materials. This is not necessarily the case for structural or prox-

imity fire-fighting protective clothing, particularly after exposure to products of combustion.

**A.3.3.46 Hazardous Materials.** Hazardous materials are any solid, particulate, liquid, gas, aerosol, or mixture thereof that can cause harm to the human body through respiration, ingestion, skin absorption, injection, or contact.

**A.3.3.54 Interface Component(s).** Interface components are evaluated and tested individually or are evaluated and tested as a part of the protective element.

**A.3.3.64 Organization.** Examples of organizations include, but are not limited to, fire departments, police and other law enforcement departments, rescue squads, EMS providers, and hazardous materials response teams.

**N A.3.3.66 Preliminary Exposure Reduction.** The primary purposes for preliminary exposure reduction actions are to reduce the exposure of the individual end users to soiling, products of combustion, and persistent contamination during doffing of ensembles and ensemble elements and to minimize the spread of that contamination to apparatus, vehicles, and the outside environment. Preliminary exposure reduction techniques for the outside of the ensemble and ensemble elements include brushing off dry debris with a soft bristle brush, rinsing off debris with a low-pressure, low-volume water hose, and spot cleaning for non-aluminized elements. Only a soft cloth or sponge should be used to remove debris on aluminized element surfaces.

These actions, conducted by an individual with assistance, are intended to begin the removal of soiling and contamination as soon as practically possible following the exposure of the individual on the fireground or at the emergency scene. The goal of preliminary exposure reduction is reducing contamination for the exposed ensemble or ensemble elements prior to leaving the scene. These techniques should be applied while the member is still wearing their SCBA and is still on air to prevent respiratory exposure from any off-gassing of contaminants or to dust from airborne debris. It is realized that circumstances might not allow for this immediate action due to limitation of resources (e.g., spare ensembles or ensemble elements), inclement weather, and other factors. Therefore, preliminary exposure reduction can take place some time or distance away from the specific exposure event.

In the hazardous materials industry, these actions are often referred to by the term *gross decontamination*, indicating the rinsing of the first responder or the actions to partially remove chemical residues or other hazardous substances after leaving the hot (contaminated) zone and before entering the cold (clean) zone during a hazardous materials incident. NFPA 1851 uses the term *preliminary exposure reduction* because the term *decontamination* suggests removal of contaminant. While there is an expectation that some of the surface contamination could be removed from protective ensembles or ensemble elements, gross decontamination or preliminary exposure reduction does not guarantee full cleaning or decontamination for all parts of the protective ensembles or ensemble elements.

**N A.3.3.67 Products of Combustion.** Normal products of combustion during fires include smoke (carbon particulates) and fire gases such as carbon dioxide, water, carbon monoxide, hydrogen chloride, nitric oxide, and a large number of other chemicals at different concentrations. The type and quantities of combustion products produced during a fire extensively vary

with the type of fuels and fire conditions. The majority of fires are highly complex and entail a myriad of different materials that serve as fuels and create a large number of chemicals that are carcinogenic, are toxic, are corrosive, or create allergic reactions. Many products of combustion could include chemical substances that are persistent due to their low relative volatility or their adsorption onto soot or carbon particles created during combustion.

**A.3.3.73 Proximity Fire Fighting Protective Ensemble.** A proximity fire fighting protective ensemble includes, but is not limited to, garments, helmets, shrouds, gloves, and footwear.

**A.3.3.81 Radiological Particulate Terrorism Agents.** This standard addresses protective ensembles that provide only partial protection from certain radiation sources. By their nature, these ensembles provide protection from alpha particles; the element materials and distance will significantly attenuate beta particles. These ensembles do not provide any protection from ionizing radiation such as gamma- and X-rays other than to keep the actual radiological particulates from direct skin contact.

**N A.3.3.83 Sanitizer.** Like disinfectants (*see* A.3.3.22), sanitizers are considered a pesticide and thus subject to regulations established by the U.S. Environmental Protection Agency (EPA). All sanitizers must be registered with the EPA and meet specific labeling requirements. A listing of currently registered sanitizers can be found at <https://www.epa.gov/pesticide-registration/selected-epa-registered-disinfectants>. Sanitizers are required to be used as specified on the product label as determined by the EPA registration process.

Sanitizers can either be used on hard surfaces such as helmet shells and eye and face protection devices, or be used as presoak treatments or laundry additives for fabrics and textiles. The specific requirements for demonstrating acceptable performance are found in the following EPA Office of Chemical Safety and Pollution Prevention (OCSPP) product performance test guidelines:

- (1) OCSPP 810.2300, "Sanitizers for Use on Hard Surfaces — Efficacy Data Recommendations"
- (2) OCSPP 810.2400, "Disinfectants and Sanitizers for Use on Fabrics and Textiles — Efficacy Data Recommendations"

Both of these documents provide for different classifications of disinfectants for their intended use. Classification types include sanitizers for food contact products and non-food contact products. Specific procedures and different target microorganisms are utilized to demonstrate the effectiveness of the respective sanitizer. In general, a sanitizer must reduce the number of microorganisms by 99.9 percent (a 3 log<sub>10</sub> reduction).

See A.7.4.3 for more information on registered sanitizers.

**A.3.3.84.1 Major A Seam.** Outermost layer seam assemblies include outer shell seams. Rupture of the outer shell could reduce the protection of the garment by exposing inner layers such as the moisture barrier and the thermal barrier.

**A.3.3.84.2 Major B Seam.** Inner layer seam assemblies include moisture barrier and thermal barrier seams.

**N A.3.3.90 Soiling.** Soiling excludes contaminants that could adversely affect the wearer such as products of combustion and other hazardous materials, including toxic, corrosive, or sensitizing chemicals, potentially infectious body fluids, other infec-

tious microorganisms, and CBRN terrorism agents. Since many fireground exposures with entry into a structure will involve exposure to combustion products that contain hazardous chemicals and other substances including carcinogens, any exposure to these conditions could result in contamination.

**A.3.3.96 Structural Fire Fighting Protective Ensemble.** A structural fire fighting protective ensemble includes, but is not limited to, garments, helmets, hoods, gloves, and footwear.

**N A.3.3.103 Structural Fire Fighting Particulate Blocking Hood.** These protective hoods have been designed to reduce the penetration of particulate contamination from reaching the end user. Hoods are required to meet NFPA 1971 and requirements for particulate blocking hoods.

**A.3.3.112 Universal Precautions.** Under circumstances in which differentiation between body fluids is difficult or impossible, all body fluids should be considered potentially infectious materials.

**Δ A.4.1.1 NFPA 1500 and NFPA 1581** also provide requirements and information on cleaning and decontamination.

Protective ensembles and ensemble elements are important tools that enable fire fighters to perform their jobs in a safe and effective manner. Organizations need to recognize that these items do not have an indefinite life span and that regular inspections are a necessary part of any protective equipment program.

**Δ A.4.2.2** The following sample outline for an SOP is provided as a guide to aid organizations in the development of their program SOPs. Organizations should consider addressing each point in the outline based on their types of protective clothing, operations, situation, needs, and so forth. The SOP should also include the responsibilities of the organization and of the individual members for each of the following points in the outline:

- (1) Records, as follows:
  - (a) Issued
  - (b) Manufacturer information
  - (c) Maintenance
  - (d) Retirement
- (2) Protecting the public and personnel from exposure to contaminated PPE, as follows:
  - (a) Risk assessment
  - (b) Contamination containment
  - (c) Public access
  - (d) Procedures, as follows:
    - i. Public areas
    - ii. Living areas
    - iii. Food preparation and eating areas
    - iv. Training areas
    - v. Other
- (3) Selection, as follows:
  - (a) Risk assessment
  - (b) Compliance with NFPA 1971
  - (c) Element evaluation
- (4) Inspection, as follows:
  - (a) Routine inspection
  - (b) Routine inspection procedure points
  - (c) Advanced inspection
  - (d) Advanced inspection procedure points
- (5) Cleaning, as follows:

- (a) Preliminary exposure reduction
- (b) Preliminary exposure reduction procedure points
- (c) Advanced cleaning
- (d) Advanced cleaning procedure points
- (e) Drying procedures points
- (6) Repair, as follows:
  - (a) Basic repairs
  - (b) Advanced repairs
  - (c) Moisture barrier repairs
- (7) Storage, as follows:
  - (a) Unissued storage
  - (b) Issued storage
- (8) Retirement, disposition, and special incident procedures, as follows:
  - (a) Condition
  - (b) Age
  - (c) Disposal method

**▲ A.4.2.3** Emergency response organizations are cautioned that accessories could degrade the protection or performance of the certified ensemble or ensemble element; interfere with form, fit, or function of the certified ensemble or ensemble element; or become a hazard to the wearer.

Accessories are not part of the certified ensemble or ensemble element but could be attached to a certified ensemble or ensemble element by means not engineered, manufactured, or authorized by the certified ensemble or ensemble element manufacturer. If an accessory or its means of attachment causes the structural integrity of the certified ensemble or ensemble element to be compromised, the certified ensemble or ensemble element might not be compliant with the standard with which it was originally certified.

Additionally, if an accessory or the accessory's means of attachment is not designed and manufactured from suitable materials for the hazardous environments of emergency incidents, the failure of the accessory or the means of attachment could cause injury to the emergency responder.

Users are also cautioned that the means of attachment for an accessory that fails to safely and securely attach the accessory to a certified ensemble or ensemble element can allow the accessory to become inadvertently dislodged from the certified ensemble or ensemble element, possibly posing a risk to emergency response personnel in the vicinity.

Organizations should consider evaluating the ensemble with tests provided in NFPA 1971 in which the accessory could negatively impact the performance of the ensemble element, when in place. One test that is not part of NFPA 1971 but could be used to evaluate the performance of an externally placed accessory is ASTM F1930, *Standard Test Method for Evaluation of Flame Resistant Clothing for Protection Against Flash Fire Simulations Using an Instrumented Manikin*. This test provides a simulation of a flash fire exposure using a static manikin. The effects of the flash fire on the accessory can be determined and compared to an ensemble that does not have the accessory in place. A minimum exposure time of 10 seconds is recommended for evaluating structural or proximity fire fighting ensembles. While this test provides a demonstration of ensemble/accessory performance under emergency conditions, it does not simulate all fire ground hazards, and other evaluations should be considered.

**A.4.2.3.1** See A.4.2.3.

**▲ A.4.2.3.2** Organizations should consider evaluating the ensemble or ensemble element with tests provided in NFPA 1971 in which the accessory could negatively affect the performance of the ensemble or ensemble element, depending on how the element might be affected by the attachment of the accessory (see Table A.4.2.3.2).

Another test that can be used to evaluate the performance of an externally placed accessory is ASTM F1930, *Standard Test Method for Evaluation of Flame Resistant Clothing for Protection Against Fire Simulations Using an Instrumented Manikin*. This test simulates a flash fire exposure using a static manikin. The effects of the flash fire on an ensemble or ensemble element with the accessory can be determined and compared to the effects on an ensemble or ensemble element that does not have the accessory in place. A minimum exposure time of 10 seconds is recommended when evaluating structural or proximity fire-fighting ensembles. While this test demonstrates ensemble/accessory or ensemble element/accessory performance under emergency conditions, it does not simulate all fire-ground hazards, and other evaluations should be considered.

**A.4.2.3.3** See A.4.2.3.2.

**A.4.2.4** A manufacturer-trained organization receives training from an element manufacturer or a verified ISP in cleaning,

**▲ Table A.4.2.3.2 Evaluating Possible Negative Effects of Accessory Attachments on Ensembles or Ensemble Elements**

Ensemble and Ensemble Element Properties	Applicable Sections of NFPA 1971
Garments	
Flame resistance	8.2
Heat resistance	8.6
Whole-garment liquid integrity	8.48
Helmets	
Flame resistance	8.3
Heat resistance	8.6
Top-impact resistance	8.15
Impact resistance	8.16
Electrical insulation	8.30
Gloves	
Flame resistance	8.4
Heat resistance	8.6
Overall liquid integrity	8.32
Glove-hand function	8.37
Grip	8.38
Footwear	
Flame resistance	8.5
Heat resistance	8.6
Electrical insulation	8.31
Slip resistance	8.40
Overall liquid integrity	8.27.9
Hoods	
Flame resistance	8.2
Heat resistance	8.6
Liquid and particulate contamination protective ensembles	
Particle inward leakage	8.66
Whole ensemble liquid integrity	8.48

inspection, and repair services for that organization's own elements. For garment elements, this entity has not received any formal verification from a third-party certification organization. If an organization has received training in cleaning, inspection, and repair of elements, it can be permitted to utilize another organization's equipment to conduct cleaning, inspection, or repair. For example, if organization A purchases a washer/extractor and neighboring organization B wishes to utilize this washer/extractor, it can be permitted to do so; however, organization B must use its trained personnel to conduct the laundering. If organization B wishes to use organization A's equipment and personnel to conduct the laundering, then organization A must be a verified organization [see 4.2.4(2)].

A verified organization has demonstrated the ability to conduct cleaning, inspection, and repairs to a third-party certification organization in accordance with this standard and is not required to have the approval of the element manufacturer to perform these services. Verified organizations are permitted to conduct these services for other organizations.

A verified ISP has demonstrated the ability to conduct cleaning, inspection, and repairs to a third-party certification organization in accordance with this standard and is not required to have the approval of the element manufacturer to perform these services.

A manufacturer verified in cleaning has demonstrated the ability to conduct cleaning to a third-party verification organization in accordance with this standard. A verified cleaner has demonstrated the ability to conduct cleaning to a third-party certification organization in accordance with this standard.

**Δ A.4.2.4.2** Although approval from a manufacturer is not a requirement of this standard, it might be advantageous for the specific element manufacturer to be consulted when there is any question concerning the appropriate cleaning, inspection, or repair of a specific element. NFPA 1971 requires that every certified element contain the name and address of the element manufacturer so this information is readily available and each manufacturer will be able to offer the best possible practical knowledge of its product.

**A.4.2.4.3** The end user should always request the list of repair categories for which the verified ISP is approved to perform.

**N A.4.2.4.3.1** Verified cleaners have received verification from a third-party verification organization to conduct garment element advanced cleaning services. Verified cleaners are not third-party verified to conduct advanced inspections or repairs.

**N A.4.2.4.5** This training is not required for every member of the organization. Organizations are allowed to determine the personnel who will receive this training. Typically, organizations require only the personnel who are involved in their PPE program to receive this training. In some cases organizations choose to also train selected personnel from each shift. Safety officers, training officers, and risk managers could also find this training beneficial.

For organizations that wish to perform basic garments repairs, additional hands-on training from the garment manufacturer or verified ISP is necessary. In addition, equipment and materials are needed to conduct basic garment repairs.

Organizations might be able to conduct some types of decontamination. Decontamination processes are dependent

on the type of contaminate and could require specialized processes performed by a verified ISP. Additional information is provided in Chapter 7.

**N A.4.2.4.5.1** All ISPs, manufacturers, and verified cleaners performing advanced garment cleaning are required to successfully verify the effectiveness of cleaning for garment elements. If a department wants more in-depth information or specifics on how to perform garment cleaning, they should consult with an ISP or a manufacturer who has been third-party verified in cleaning.

**N A.4.2.4.5.2** Training should explain the activities that organizations are required to perform in order to comply with this standard, as well as provide information and options in regard to how organizations can accomplish them. This training does not negate the need for organizations to consult with manufacturers on specific instructions for performing inspections or basic repairs on proprietary products, individual ensemble elements, fabrics, or components with unique attributes or performance that require special consideration. For cleaning, it might be necessary to consult a manufacturer who has been verified in cleaning.

**N A.4.2.4.5.3** Written documentation of training should include:

- (1) Organization name
- (2) Personnel names
- (3) Date trained
- (4) Entity providing the training
- (5) Edition of NFPA 1851 enforced at the time of the training
- (6) Elements of NFPA 1851 for which the organization has been trained
- (7) If applicable, indication that the organization received additional hands-on training necessary to conduct basic garment repairs

**A.4.2.5** Retirement criteria should be based on a number of factors, including, but not limited to, the overall condition of the item, specific deterioration of materials or components beyond their repair economically, or the inability to adequately remove hazardous materials and other contaminants. Physical damage from use or improper cleaning are other factors that can affect when an item should be retired. The actual service life of ensembles and ensemble elements varies, depending on the amount of their use and the care they receive.

**A.4.3.1** Records are an important part of an overall protective ensemble management program. Records can be used to provide information about the life cycle of protective ensembles and ensemble elements, to document cleaning and repair efforts, and to compare the effectiveness of elements that are made of different materials or by different manufacturers. These records can be compiled and maintained by the organization, a verified ISP, a verified cleaner, another third party selected by the organization, or any combination thereof.

**A.4.3.2** Some departments utilize rental or loaner gear. Records should also be maintained on these ensembles and ensemble elements in order to maintain a history on the care and maintenance of the products. The fire department should require that the entity providing the gear provide the records of prior care and maintenance at the time of rental.

**N A.4.3.5** Organizations might place some elements in a rotating exchange program rather than assign them to a member. For example, some organizations keep an inventory of clean hoods they exchange after each contamination exposure. The

member keeps a hood until it is contaminated and then exchanges it for a clean hood. The hood is never assigned to a specific member. Other elements might also be placed in a similar rotating exchange program.

**A.4.4.2** It should be noted that the intent of this requirement is not to allow manufacturers to dictate which verified ISP an organization must use. The organization is allowed a choice in service providers for cleaning, inspection, and repairs. Also, this paragraph is not intended to imply that any of the requirements in this standard can be circumvented. The intent is to allow manufacturers to provide instructions that could differ from this standard, if necessary, due to a specific design feature, component, or material that requires special care or when an issue is not addressed by this standard. Any variations should be limited to the method of inspection, cleaning, or repair, not to the frequency.

**A.4.5.2** Living areas include kitchen and dining areas, dayrooms, sleeping areas and dormitories, dedicated fitness rooms, bath and shower areas, office areas, and meeting and conference rooms.

**A.4.5.3** Extra caution should be practiced to avoid exposing children to soiled protective equipment because they usually are more interested in actually touching or handling the equipment than are adults. Children are also less likely to wash off any dirt or soot that they might pick up from handling ensembles or ensemble elements. Departments should consider dedicating PPE solely for use at public education events, to minimize public exposure to soils and contaminants.

Fire fighters often have a need to enter public facilities such as restaurants, grocery stores, and other businesses as part of their routine activities. PPE should not be worn during those times.

**N A.4.5.4** Public facilities include, but are not limited to, the home, home laundries, public laundries, commercial laundries, dry cleaners, stores, offices, private cars, and private homes. All efforts must be made to prevent exposing the public to soil and contaminants.

**A.4.6.1** The purpose of this subsection is to require notification to the manufacturer and the certification organization of all health and safety concerns related to PPE identified through use or inspection. If a known or suspected failure of an ensemble element is identified, the element manufacturer and certification organization are the appropriate parties to be notified.

PPE health and safety concerns include, but are not limited to, the following:

- (1) An occurrence resulting in loss of life or that which is likely to cause loss of life
- (2) An injury resulting in permanent bodily damage, which can be instantaneous or cause a life-limiting disease or disorder eventually resulting in death
- (3) An injury that requires hospitalization or medical or surgical treatment and that is not likely to result in a permanent disorder but is likely to necessitate loss of work for more than one day

**A.4.6.2** The manufacturer and the certification organization information can be found on the product label.

**A.5.1** The organization should consider establishing a committee to oversee the process of selecting ensembles or

ensemble elements. The committee should consist of interested individuals representing a cross section of the organization (i.e., from both labor and management who collectively have several years of experience in fire fighting activities). The role of the committee should be to set and define goals and requirements and identify areas of responsibility for each member, plus provide recommendations to the authority making the final decisions.

Copies of specifications on the organization's current ensembles and ensemble elements should be distributed to the committee as a point of reference. The committee should consider if there are possible areas for improvement to the existing specifications. Examples of improvement criteria over existing specifications include heat stress, weight, design, style, interface with other components, durability, comfort, flexibility, safety, performance, price, customer service, delivery, compliance, reliability, and warranty.

**Δ A.5.1.1** In general, some hazards that can be encountered include, but are not limited to, physical, environmental, thermal, chemical, biological, electrical, radiation, operational, and ergonomic hazards. The organization should also consider the frequency and severity of the identified hazards when conducting the risk assessment.

The safety officer is the logical individual to perform this function since that is his or her role in the organization. The safety officer should consider national trends when performing this task. NFPA 1500 substantiates OSHA's regulations as follows:

- (1) Section 4.3: Mandatory evaluation of safety and health programs
- (2) Subsection 4.4.2: Mandatory compliance with state and federal laws
- (3) Section 4.7: Safety officer's responsibilities also defined in NFPA 1521
- (4) Section 7.1: Requirements for ensembles and ensemble elements

In the identification of hazards, the organization should consider those hazards that fire fighters are likely to encounter. A list of hazards is provided in Table A.5.1.1. In determining risk, the organization should consider the frequency or likelihood of exposure to the hazard along with its potential severity (consequence) if exposure occurs.

**A.5.1.2(1)** In performing the risk assessment, the organization should consider all of its responsibilities. In some departments there might be stations or units that require different types of ensembles.

**Δ A.5.1.2(6)** Examples of physical areas of operations include but are not limited to:

- (1) One of the hazards faced by fire fighters is being struck by vehicular traffic. The high-visibility materials required on fire fighter PPE effectively enhance visual conspicuity during the variety of fireground operations. The continuous use of high-visibility garments is one component of a strategy to mitigate risks from struck-by hazards, which are known to cause serious fire fighter injuries and fatalities on an annual basis. Additional high-visibility requirements for fire fighters on or near roadways are regulated by the Federal Highway Administration's *Manual on Uniform Traffic Control Devices (MUTCD)*. It is the responsibility of the authority having jurisdiction (AHJ) to specify



**Table A.5.1.1 List of Potential Fire Ground and Other Related Emergency Hazards**

<b>Physical Hazards</b>	<b>Chemical Hazards</b>
Falling objects	Inhalation
Flying debris	Skin absorption or contact
Projectiles or ballistic objects	Chemical ingestion or injection
Abrasive or rough surfaces	Liquefied gas contact
Sharp edges	Chemical flashover
Pointed objects	Chemical explosions
Slippery surfaces	<b>Electrical Hazards</b>
Excessive vibration	High voltage
<b>Environmental Hazards</b>	Electrical arc flashover
High heat and humidity	Static charge buildup
Ambient cold	<b>Radiation Hazards</b>
Wetness	Ionizing radiation
High wind	Non-ionizing radiation
Insufficient or bright light	<b>Person-Position Hazards</b>
Excessive noise	Daytime visibility
<b>Thermal Hazards</b>	Nighttime visibility
High convective heat	Falling
Low radiant heat	Drowning
High radiant heat	<b>Person-Equipment Hazards</b>
Flame impingement	Material biocompatibility
Steam	Ease of contamination
Hot liquids	Thermal comfort
Molten metals	Range of motion
Hot solids	Hand function
Hot surfaces	Ankle and back support
<b>Biological Hazards</b>	Vision clarity
Bloodborne pathogens	Communications ease
Airborne pathogens	Fit (poor)
Biological toxins	Ease of donning and doffing
Biological allergens	

appropriate high-visibility apparel from the available garment options, if any, and based on a risk assessment, to establish policies for use in accordance with prevailing regulations (the MUTCD) and in compliance with applicable standards (e.g., NFPA 1971, ANSI/ISEA 107, *American National Standard for High Visibility Safety Apparel and Accessories*, ANSI/ISEA 207, *American National Standard for High Visibility Public Safety Vests*).

- (2) The use of personal flotation devices might need to be considered for operations near waterways.
- (3) Fire fighters operating at elevation might need some form of fall protection, which might or might not be incorporated into their protective clothing.

**Δ A.5.1.2(7)** In determining the need for CBRN protection, the organization should determine homeland security priorities for its jurisdiction, including, but not limited to, whether the organization would be responding to a CBRN terrorism incident, the specific roles and missions to be undertaken in response to a CBRN terrorism incident, the expected types of hazards that might be encountered for its members during a CBRN terrorism incident, and the capabilities of the organization to provide sufficient training and support for the use of CBRN protective ensembles (e.g., decontamination for safe doffing of ensemble elements). If it is determined that CBRN

protection is needed, the organization should review the different classes of ensembles addressed in NFPA 1994 and the protective ensemble defined in NFPA 1991, together with its intended CBRN terrorism agent response or action plan, to determine the suitability of obtaining separate ensembles that comply with specific classes of ensembles for NFPA 1994 or ensembles meeting NFPA 1991.

**Δ A.5.1.3** These standards provide minimum requirements. In order to fully utilize this standard, organizations should be familiar with the performance requirements in NFPA 1971. Additional requirements can be necessary. Organizations should also solicit information from and exchange information with other organizations.

**Δ A.5.1.4** Certification of protective elements can be checked by examination of the product label for the mark of the certification organization. The organization should further check the certification of the specific protective element by contacting the certification organization and asking if the item is listed as being certified as compliant with NFPA 1971. Finally, the organization can check the legitimacy of the certification organization by asking for documentation that shows that the certification organization has been accredited to ISO/IEC 17065, *Conformity assessment — Requirements for bodies certifying products, processes and services*.

**Δ A.5.1.5** The majority of tests in NFPA 1971 provide quantitative results; however, some tests are established on the basis of pass or fail results and cannot be readily compared. Specific tests that offer comparative performance results include, but are not limited to, the following:

- (1) Protective garment elements
  - (a) Thermal protective performance of the material composite
  - (b) Total heat loss of the material composite
  - (c) Conductive and compressive heat resistance of reinforcements
  - (d) Thermal shrinkage of the material layers (outer shell, moisture barrier, thermal barrier)
  - (e) Flame resistance of material layers and other components (outer shell, moisture barrier, thermal barrier, other material layers and components)
  - (f) Tear resistance of the material layers (outer shell, moisture barrier, thermal barrier)
  - (g) Cleaning shrinkage of the material layers (outer shell, moisture barrier, thermal barrier)
  - (h) Water absorption resistance of the outer shell
  - (i) Tensile strength of the outer shell
  - (j) Seam strength of outer shell, moisture barrier, and thermal barrier layers
  - (k) Visibility properties of the trim
  - (l) Radiant reflectance of the outer shell (for proximity fire fighting protective clothing)
- (2) Protective helmet elements
  - (a) Impact resistance (top and acceleration) after selected preconditions
  - (b) Flame resistance
  - (c) Heat resistance (level of sagging)
- (3) Protective glove elements
  - (a) Thermal protective performance of glove body and, if present, wristlet
  - (b) Conductive heat resistance of glove body
  - (c) Thermal shrinkage of glove and innermost material

- (d) Cut resistance of glove body
- (e) Puncture resistance of glove body
- (f) Burst strength of wristlet material
- (g) Dexterity of whole gloves
- (h) Grip of whole gloves
- (4) Protective footwear elements
  - (a) Flame resistance
  - (b) Radiant heat resistance of upper
  - (c) Conductive heat resistance of sole and upper
  - (d) Puncture resistance of sole and upper
  - (e) Cut resistance of upper
  - (f) Abrasion resistance of sole
- (5) Protective hood interface elements
  - (a) Thermal protective performance of hood material
  - (b) Flame resistance of hood material
  - (c) Thermal shrinkage of hood material
  - (d) Burst strength of hood material
  - (e) Cleaning shrinkage of hood material
  - (f) Particulate contamination blocking layer

Additional testing can also be specified for performance properties not addressed in NFPA 1971 based on the organization's hazard and risk assessment. When additional testing is specified, standard test methods should be used when available, and testing should be conducted at accredited, independent laboratories.

Organizations should consider the use of a request for information (RFI) or a request for proposal (RFP) format when soliciting quotations for structural or proximity fire fighting protective ensemble elements. The advantage of an RFI or an RFP proposal is that it allows manufacturers the option of providing all of the most current technologies for organization review (the offering is then not limited to the requirements of the specification). The organization can then choose among proposals for offered items finally accepted. Typically an RFI and an RFP have the following characteristics:

- (1) Minimum requirements, such as NFPA product certification, required materials, or available options
- (2) Inclusion of current specifications and a requirement that each manufacturer explain how its offering differs from the currently specified product
- (3) Background on the offering firm's finances, capabilities, and references
- (4) Field test procedures and results (*see 5.1.6*) of offered products

Using this approach, the organization can then employ a rating system that assigns values and weights to several factors, including, but not limited to, product design, manufacturer references, and field test results.

In this approach, a separately sealed cost proposal is opened only after the point ratings have been assigned to each offering. The organization can then apply separate criteria considering both technical merits and cost. This approach allows fire departments to compare prices and product acceptability.

Organizations should also consider integrated PPE programs that address various levels of care and maintenance as provided by or coordinated by the manufacturer of the fire fighter personal protective equipment. These programs can address many of the aspects of care and maintenance that are addressed in this standard, including, but not limited to, clean-

ing, inspection, and repairs, in addition to the offer of program guidance and reporting and documentation of procedures.

**N A.5.1.5.1** Tradeoffs exist between the levels of thermal insulation provided by garment composite materials and the ability of those materials to trap heat that potentially leads to heat stress of the fire fighter. In NFPA 1971, thermal protective performance (TPP) testing measures the amount of heat transfer through the clothing composite (i.e., the combination of the primary garment clothing layers — the outer shell, the moisture barrier, and the thermal barrier) when exposed to a combination of convective heat and thermal radiation. The exposure level is intended to simulate the heat energy associated with a flashover. The test uses a calorimeter to measure the time-to-burn. The reported TPP rating is this time-to-burn multiplied by the exposure energy (2.0 cal/cm<sup>2</sup>/sec). It is important to recognize that TPP testing simulates only one condition among an unlimited set of clothing exposure conditions. However, the TPP test is the primary measurement for qualifying garment composite material for thermal insulation. The minimum TPP value specified by NFPA 1971 for garment composites is 35.0 cal/cm<sup>2</sup>/sec. Higher values of TPP indicate composites offering greater thermal insulation.

A total heat loss (THL) test is used to measure how well garments allow body heat to escape. The test assesses the loss of heat, both by the evaporation of sweat and the conduction of heat through the garment layers. As clothing is made more insulative to high heat exposures, there is a tradeoff with how well the heat build-up in the fire fighter's body (that can lead to heat stress) is alleviated. Differences in the weight and other characteristics of garment material composites including the type of moisture barrier will affect the transmission of sweat moisture, which carries much of the heat away from the body. If this heat is kept inside the ensemble, the fire fighter's core temperature can rise to dangerous levels if other efforts are not undertaken (i.e., limiting time on scene, rotating fire fighters, and providing rehabilitation at the scene). NFPA 1971 specifies that garment composites have a minimum THL of 205 W/m<sup>2</sup>. Higher THL values indicate composites that provide greater heat loss. The validation and origin of this requirement is discussed in ASTM STP1386, *Field Evaluation of Protective Clothing Effects on Fire Fighter Physiology: Predictive Capability of Total Heat Loss Test*.

There are also limitations in the application of THL testing. Just as TPP testing only evaluates the base three-layer fabric system for thermal insulation, THL testing is a material test and does not evaluate the entire capability of the garment to dissipate heat. Areas of garments with additional layers such as trim, pockets, and reinforcements have less breathability. In contrast, these same areas of the garment have greater thermal insulation. The specifications of garment design must account for which areas of the garment need reinforcement and other materials and how these additional materials and reinforcements could contribute to stress.

Organizations should be aware that small differences in TPP and THL values might not represent significant differences that will translate into differences in field performance of garments. There is variation in the test results for both TPP and THL where values of  $\pm 3$  cal/cm<sup>2</sup> in TPP and values of  $\pm 20$  W/m<sup>2</sup> in THL might be due to variation in results produced by the materials rather than true differences in the garment composite materials.

In general, as garment material composite thickness increases, higher levels of thermal insulation (measured using TPP testing) are obtained. At the same time, thicker composites typically create more stress on the fire fighter. By also examining the results of THL testing, organizations can choose to optimize the selection of their composites by balancing composite THL values with TPP values, while still meeting the minimum performance for both areas of performance. For TPP testing, thermal barriers usually have the greatest impact, but like THL, the TPP value for a composite is based on the contribution from each layer.

Other measurements can be introduced to characterize garment material composite thermal insulation or heat stress effects. For example, the evaporative resistance test (referred to as Ret), which is also performed on the three base layers, offers a means for measuring the ability of the garment composite to allow the heat associated with sweat evaporation to pass through the material. Like THL, this test is associated with demonstrating the breathability of the garment material composite. In this test, different environmental conditions provide a different way of ranking composite performance, although there are no established performance requirements for Ret within NFPA 1971. Specific research conducted by North Carolina State University using a physiological manikin and reported by the Fire Industry Education Resource Organization (F.I.E.R.O.) have shown that Ret provides discrimination of the composite materials' impact on wearer core temperature, skin temperature, and sweating rate with a higher correlation than THL over three different environmental conditions — hot, mild, and warm. This information means that Ret might provide a more reliable prediction and discrimination of the stress effects of different material composites on the protective clothing wearer as compared to THL. Unlike THL, the reported Ret measurement is a resistance having units of  $\text{Pa m}^2/\text{W}$  where lower values are associated with more breathable material composites.

Organizations should be aware that the measurements of garment material composite thermal insulation and heat stress effects are performed on the principal three-layer composite used in the construction of the garment and do not account for other layers that might be on the garment such as trim, pockets, outer shell reinforcements, and liner reinforcements. While necessary to meet the requirements of the standard and assist fire fighters in performing their duties, these additional layers increase overall thermal insulation and decrease breathability, resulting in potentially higher heat stress effects. Consequently, when deciding on the target levels of composite thermal insulation and breathability (i.e., total heat loss or evaporative resistance), organizations should take into account the garment design and how both thermal insulation and heat stress effects will be affected by both mandatory (e.g., trim, shoulder reinforcements, knee reinforcements) and optional (e.g., pockets) garment design features. Results for the investigation of these effects is provided in “The Cost of a Pocket: the Impact of Reinforcements on the TPP and THL.”

**N A.5.1.6** Organizations are able to assess the effectiveness of ensemble interfaces, interface components and proper donning for reducing the penetration of particulate contamination by conducting a simple test. In this test, a fire fighter wears their ensemble consisting of protective garments, a helmet, gloves, footwear, a hood, and self-contained breathing apparatus (SCBA). A fluorescent agent-based solution is sprayed as an aerosol onto the exterior of the protective ensemble

worn by the fire fighter, while the fire fighter carries out stationary exercises. When applied as a fine mist, the aerosol can approximate the small particles of smoke created in a structural fire. After carefully removing the ensemble, the underlying skin and clothing are examined under a black UV light to show any evidence of aerosol penetration. This information can then be used by the organization to judge how well interfaces are maintained between elements, the overall protective capabilities of specific interface components such as particulate blocking hoods, and the efficacy of donning methods.

For performing this test, the following supplies, equipment, and facilities are needed:

- (1) A commercial fluorescent liquid solution that is typically applied in hand washing. A supply of 3.8 L (1 gal) will be sufficient to evaluate multiple ensembles.
- (2) An ordinary paint spray with a variable control. An inexpensive electric-powered sprayer can be obtained for less than \$100 from a home improvement supply store.
- (3) A large black UV flashlight for viewing any fluorescent aerosol. Alternatively, a bank of long black UV fluorescent lights can be used in a darkened room.
- (4) An area that can be darkened for examining the fire fighter test subject under black light. This area can be a closet or other room where the light can be fully blocked out.
- (5) An area for spraying the liquid onto the fire fighter test subject.
- (6) Optionally, the fire fighter test subject can wear black witness garments such as body wear underneath the ensemble to provide a uniform viewing surface. If this approach is used, synthetic material-based black body wear consisting of a full long-sleeved top and pants are useful. However, such garments must be totally free of lint as ascertained by being checked under a black light.

The basic procedures for conducting this test involve the following steps:

- (1) Spray a very small portion of fluorescent solution (1 sec) onto either the black witness garment or the individual's skin to determine how it appears under the selected black light observation conditions. This will serve as a visual control for determining if penetration has occurred.
- (2) The fluorescent solution should rinse off the individual's skin with thorough soap-and-water washing. It should also be readily removed from the black witness garments by conventional washing.
- (3) If the fire fighter test subject wears the black witness garments, then the garments should be washed and free of lint.
- (4) Put the fluorescent liquid in the sprayer reservoir and adjust the sprayer settings to deliver a light, circular spray pattern of liquid mist.
- (5) Have the fire fighter test subject put on the complete ensemble to be evaluated.
- (6) Spray the fluorescent liquid onto the fire fighter ensemble using a spray time of 5 to 10 seconds in each location. Ideally, have the test subject perform motions that are designed to challenge the interfaces, such as reaching above their head with their arms, bending over, and cross-body reaches.
- (7) Following the spraying of fluorescent liquid, use extreme care removing the ensemble from the fire fighter test subject to prevent contaminant transfer to the interior and skin/clothing of the subject.

- (8) After the ensemble is removed, check the surfaces on the black witness garments or test subject's skin under a black UV light in a darkened area to determine if there is any visual evidence of fluorescence that might have penetrated from the spraying process.
- (9) Make notes or draw a diagram to show where underlying fluorescence has penetrated portions of the ensemble or the test subject's skin.

Based on this test method, information gained from the evaluation of different ensembles can show their relative effectiveness in preventing particulate penetration. However, it is important to note that this evaluation technique might not show all avenues of particulate penetration and can also provide results that might be difficult to interpret unless specific penetration pathways are identified. It is important to carry out these procedures with a high level of advance planning and scrutiny to ensure consistent and comparable results. For example, conducting the evaluation with the same test subject(s) on the same day will allow more uniform testing when comparing different ensembles. Also, note that the donning process can impact the results of this procedure.

**N A.5.1.6.1** More than one type of eye and face protection component as provided with the helmet or separate eye and face protection devices might be needed to cover the full range of activities for which the organization conducts emergency response operations. For example, while the full facepiece of the self-contained breathing apparatus (SCBA) provides primary eye protection during structural fires including overhaul, organizations might rely on faceshields and goggles provided with helmets for eye and face protection when not wearing the SCBA facepiece. To fulfill this requirement, an organization might have to specify separate eye and face protection devices that are suitable for providing individual member protection during other types of emergency operations.

**A.5.1.7** Organizations should contact manufacturers or vendors about field evaluation programs. Many provide sample items for tests. The following criteria should be used to conduct an effective field evaluation:

- (1) Test participants should be selected based on a cross section of personnel, willingness to participate, objectivity, and level of operational activity.
- (2) Participants should conduct field evaluations of each different product model being evaluated from each manufacturer for a particular ensemble element. Participants should be fitted for each product model being evaluated from each manufacturer. Evaluations should be conducted with the same participants to use and evaluate each ensemble.
- (3) A product evaluation form should be developed for each element and interface area. The form should include a rating system for those characteristics considered important to the organization, facilitating a quantitative evaluation. Evaluation forms should include general performance criteria, a specific length of time for the field evaluation, and criteria addressing ease of movement, ability to work, and so forth. Size and fit issues should be addressed since they relate to comparative evaluation of ensembles and ensemble elements. Evaluation forms that provide only narrative responses should be avoided.
- (4) The organization should solicit periodic reports from participants in the field evaluation. At least three evalua-

tion reports should be completed and filled out independently.

- (5) The organization should conclude the evaluation process in a timely manner and analyze the results.

**Δ A.5.1.8** Specifications translate the organization's needs into performance or design requirements that can be met by manufacturers of protective equipment. Specifications should clearly address every aspect of the department's needs and expectations in regard to both the performance and the delivery of the ensembles or ensemble elements.

Organizations should specify delivery time requirements and, if appropriate, penalty assessments for not meeting delivery dates. Warehousing requirements, if desired, should also be established in the procurement specification.

Organizations should be careful not to write specifications that are redundant or contradictory or that cannot be met by manufacturers of ensembles or ensemble elements. For example, the organization should be sure the thermal protection performance (TPP) specified can be achieved with the materials specified. A prebid meeting with participation by potential bidders or manufacturers is useful in eliminating inconsistencies and explaining requirements that might be unclear in the specifications.

Organizations should continuously review and document how their specifications and ensembles and ensemble elements meet their needs and applicable standards. There are many ways to improve the quantity and quality of information received from prospective bidders. Additionally, increased purchasing power potential can be gained by forming collective buys with other organizations for possible volume discounts.

Purchase specifications should indicate the organization's selection of choice for the following required NFPA 1971 ensemble element components:

- (1) Garments
  - (a) Outer shell material: fabric, weight, color
  - (b) Thermal liner material
  - (c) Moisture barrier material: base fabric, film, or coating
  - (d) Trim: configuration, material, color
  - (e) Closure system
  - (f) Wristlets: material, design
- (2) Hoods
  - (a) Material
  - (b) Face opening design
  - (c) Particulate contamination blocking layer
- (3) Gloves
  - (a) Composite materials
  - (b) Wristlet or gauntlet
  - (c) Wristlet material
- (4) Helmets
  - (a) Material
  - (b) Color
  - (c) Retention system
  - (d) Trim configuration
  - (e) Trim color
  - (f) Ear cover material
  - (g) Ear cover dimension
  - (h) Eye protection
- (5) Boots: composite materials

△ **A.5.1.8(2)** An organization should consider its needs for performance or features in excess of the minimum requirements of NFPA 1971, such as the following:

- (1) Garment elements, as follows:
  - (a) Any styling issues
  - (b) Any specific range-of-motion requirements
  - (c) Any sleeve retraction requirements
  - (d) Any garment rise with overhead reach requirements
  - (e) Any winter liner requirements
  - (f) Any additional reinforcement needs (recognizing that multiple layering can modify protective performance in several areas, especially breathability)
  - (g) Any specific additional thread requirements
  - (h) Any specific additional requirements for stitch characteristics
  - (i) Any customized sizing requirements
  - (j) Any attachment requirements for liners and outer shells
  - (k) Any specific requirements for placement of visibility marking, visibility marking materials, and reflective lettering
  - (l) Any specific material choices
  - (m) Any requirements for weight reduction
  - (n) Any specific details of required suspender construction or suspender/garment interface
  - (o) Any requirements for spot or localized enhanced insulative performance
  - (p) Any requirements for field interchangeability or replacement of reinforcement pieces
  - (q) Any requirements for enhanced flexibility at movement-sensitive areas
  - (r) Any requirements for notification systems to indicate liner absence
  - (s) Any requirements for moisture barrier substrate or thermal fill accessibility to allow field inspection
  - (t) Any requirements for lumbar support systems
  - (u) Any customization requirements
  - (v) Any passport or accountability system requirements
  - (w) Any specialized or additional pocketing requirements
  - (x) Any flashlight clips required
  - (y) Any personal alert safety system (PASS) interface features required
  - (z) Any requirements for personal escape or rescue features
  - (aa) Any requirements for sizing adjustment
  - (bb) Any requirements for temperature-sensing features
  - (cc) Any requirements for interface area compatibilities
- (2) Helmet elements, as follows:
  - (a) Any styling requirements
  - (b) Any customization requirements
  - (c) Any faceshield or goggles requirements
  - (d) Any reflective marking requirements
  - (e) Any customized sizing requirements
  - (f) Any specific material choices
  - (g) Any specific requirements for earflaps (e.g., design, materials, dimensions, attachment to shell specifics)
  - (h) Any specific requirements for suspension construction
  - (i) Any requirements for weight reduction

- (3) Glove elements, as follows:
  - (a) Any specific material choices
  - (b) Any overall styling requirements
  - (c) Any details of cuff styling (wristlet or gauntlet)
- (4) Boot elements, as follows:
  - (a) Any specific material choices
  - (b) Any overall styling requirements
  - (c) Any trouser interface requirements
- (5) Hood interface elements, as follows:
  - (a) Any specific material choices
  - (b) Any styling requirements
  - (c) Any coverage requirements
  - (d) Any particulate-blocking layer
- (6) All ensemble elements, as follows:
  - (a) Any additional certification requirements (e.g., Project FIRES, state OSHA, federal OSHA)
  - (b) Any requirements for interface with existing elements of the protective ensemble
  - (c) Any warranty requirements
  - (d) Any requirements for cleaning and repair support
  - (e) Any requirements for manufacturer or dealer references
- (7) Liquid and particulate contaminant protection ensembles, as follows:
  - (a) Method of deploying the liquid and particulate contaminant protection
  - (b) Position of material systems of each element and ease of their inspection
  - (c) Manner in which ensemble interfaces are designed to limit liquid and particulate contaminant ingress
  - (d) Specialized donning or doffing procedures in the wearing of the ensemble
  - (e) Ensemble resistance to contamination and ease of ensemble doffing for safe exit of wearer from ensemble
  - (f) Specific types of SCBA for which ensemble is certified

**A.5.1.8(3)** Depending on the items being purchased and the size of the order, organizations should consider requiring product representatives to provide samples with their proposals. Manufacturers should also be required to provide complete user instructions and warranty information with each bid. Organizations should review the past record of each manufacturer concerning length of time for delivery, repair turnaround times, and similar customer service issues.

**A.5.1.8(4)** Organizations can obtain assistance in garment sizing from ASTM F1731, *Standard Practice for Body Measurements and Sizing of Fire and Rescue Services Uniforms and Other Thermal Hazard Protective Clothing*. Helmets are adjustable and fit a wide range of sizes. If a helmet is not adjusted correctly, it might not stay on the user's head during periods of active wear. In addition to the sizing and depth adjustments, many models are available with quick adjusters to accommodate varying conditions for proper fitting (e.g., with or without SCBA facepiece).

**A.5.1.8(5)** Organizations should consider comparing a preproduction sample from the apparent winning submitter against the purchase specifications before awarding the bid.

**A.6.1.3** It is not the intent of this standard to require the cleaning of ensembles and ensemble elements if the elements are not soiled. Organizations should establish guidelines for

judging the extent of soiling that requires cleaning based on the organization's needs and experience. In applying such judgment, organizations should take into consideration the importance of keeping ensembles and ensemble elements clean. Soiled ensemble elements can pose a health risk to the wearer and the levels of protective performance.

**A.6.2.2** Table A.6.2.2 provides a quick reference guide to routine inspection criteria.

**N A.6.2.2(6)** The following simple evaluation can be conducted in the field to assess the integrity of the particulate-blocking layer of hoods:

- (1) Assess areas of the hood where a particulate-blocking layer is present using a bright flashlight or similar focused light to gauge the integrity of the particulate-blocking layer. The light source used should provide enough focused light to show changes in density of the hood materials when viewed. However, the light source should

not produce excessive heat that would damage the hood materials and should be configured so as to prevent the bulbs from directly contacting the hood materials.

- (2) Position the light source near the hood so that the light passes through the hood composite materials.
- (3) Evaluate the hood by examining the amount of light coming through the hood composite. Brighter areas could be an indication of material degradation, migration, or shifting resulting in a thin or bare spot, which indicates the hood should be removed from service for additional evaluation or retirement. More obvious damage such as a hole or tear in the particulate-blocking layer might also be more observable than otherwise might be seen without the addition of a light source.

**Δ Table A.6.2.2 Routine Inspection Criteria**

Criteria	Coats and Trousers	Hoods/Shrouds	Helmets	Gloves	Footwear	DRD
Soiling	X	X	X	X	X	X
Contamination	X	X	X	X	X	X
Rips, tears, abrasions, and cuts	X	X	X	X	X	X
Damaged or missing hardware and closure systems	X					
Charring, burn holes, melting	X	X	X	X	X	X
Shrinkage	X	X	X	X	X	
Material discoloration and degradation	X	X	X	X	X	X
Visibility marking integrity attachment to garment: reflectivity damage	X		X	X	X	
Loss of face opening elasticity or adjustability		X				
Cracks, dents, abrasions			X	X		
Bubbling, soft spots, warping			X			
Damaged or missing components of suspension or retention systems			X			
Damaged or missing components of faceshield/goggle system, including discoloration and scratched lenses			X			
Inverted glove liner				X		
Exposed or deformed steel toe, steel midsole, or shank					X	
Loss of water resistance					X	
Closure system component damage and functionality					X	
Earflaps: rips, tears, or cuts; thermal damage such as charring, burn holes, or melting			X			
Correct assembly and size compatibility of shell, liner, and DRD	X					X
Delamination as evidenced by separation or peeling of outer shell (aluminized materials)	X	X	X	X	X	
Any damage to the particulate blocking layer (particulate-blocking hoods only)		X				

This test might not be suitable for all types of particulate-blocking hoods, especially hoods that use an ordinary moisture barrier as the particulate-blocking layer. Some hoods might be provided with an inspection opening to allow viewing of many portions of the particulate-blocking layer.

Section 12.1 also provides an evaluation method that can be adapted for conducting a light source-based evaluation of the hood using a simple fixture.

**A.6.2.2.3(6)** The inspection should ensure that the sides and edges of faceshields and goggles are maintained to preserve peripheral vision.

**▲ A.6.3.2.1** For any inspection program to be effective, ensembles and ensemble elements should be evaluated by trained individuals. The individuals evaluating the ensembles and ensemble elements should understand the limitations of each element and recognize the signs of failure. Utilizing trained individuals provides consistency on whether an item should be repaired or retired. The manufacturer and the organization, the verified ISP and the organization, or a verified organization should determine the level of training required to perform advanced inspections. Resources for training that should be considered, as a minimum, are the manufacturer(s) of the elements in use; the Fire and Emergency Manufacturers and Services Association (FEMSA) user guides; NFPA 1500; and professional cleaning and repair facilities.

**A.6.3.3** If ensemble elements have been issued, they are not reserve and are intended to be subjected to the advanced inspection.

**A.6.3.4** The following inspection grading scale is designed to assist fire department personnel in identifying and documenting the condition of ensembles and ensemble elements:

- (1) *New or as-new condition.* Newly purchased items that are in like-new condition.
- (2) *Good condition.* Items in good serviceable condition; might show wear, but replacement or repair is not necessary.
- (3) *Maintenance needed.* Items in need of repair. The organization determines if an item is to be retired. Maintenance details are described in the “Comments” section of the inspection form.
- (4) *Immediate replacement.* Unsafe items that should be removed from service.

**A.6.3.5** Table A.6.3.5 provides a quick reference guide to advanced inspection criteria.

**A.6.3.5.1** It is important to realize during the inspection of different layers of garment elements that some portions of the material might be more susceptible to damage than others. For example, one side of a multilayer laminate material or quilted material might show damage while the other side might not. Moreover, certain fibers in a single-layer material might be more susceptible to damage than other fibers. Each of these effects could be cause for repair or retirement of the garment element, depending on the extent of observed damage. When garments have an optional winter liner, the winter liner should be inspected during each advanced inspection.

**A.6.3.5.1(3)** All charred, burned, or discolored areas should be thoroughly checked for strength and integrity by aggressive flexing of the material and attempts to push a finger or thumb through the fabric. Any loss of strength or weakening of the materials to the degree that the material can be torn with

manual pressure is a sign of deterioration, and the garment should be removed from service.

**▲ A.6.3.5.1(4)** While all materials and components in garment elements are susceptible to different types of damage from wear or abuse, the moisture barrier is one of the most difficult parts of the garment element to inspect and evaluate. That is because the film or coating side of most moisture barriers faces the interior of the liner and is hidden from easy examination. Even if a garment element is equipped with a means of opening the liner to view the film or coating side, it is difficult to conduct a visual evaluation of the moisture barrier film or coating. Even a physical examination of the moisture barrier film or coating side will not detect all types of damage or defects that can lead to loss of liquid penetration resistance for the garment element.

Moisture barrier coatings or films can become abraded, tear, or have pinholes from use. In severe cases, the degradation in some moisture barrier materials can take the form of separation, cracking, or flaking. Tapes used on moisture barrier seams, to ensure garment element integrity against liquid penetration, can crack, lift, or completely separate. Because only the most obvious damage is usually observable, the field evaluation procedures in **Section 12.3** is necessary.

A simple evaluation that can be conducted in the field to assess the integrity of the moisture barrier is as follows:

- (1) This test should be applied to areas of high wear such as, but not limited to, the broadest point of the shoulders, the back waist area of the coat, knees, crotch area, and seat area. Garment seams, discolored areas, or where potential damage to other layers has been detected should also be evaluated.
- (2) Position the garment liner, removed from the shell, over a 5-gal bucket or similar container so that the thermal liner is pointed down, and the moisture barrier is oriented upward such that it will be in contact with the liquid exposure. When testing a seam, the seam should be positioned so that it divides the test area in two equal halves. The test liquid should consist of an alcohol–tap water mixture made by combining 1 part rubbing alcohol (70 percent isopropanol alcohol) with 6 parts tap water.
- (3) Form a well in the liner area that is being evaluated so that it is lower than the surrounding liner. Pour 1 cup of the alcohol–tap water mixture onto the moisture barrier in the welled area of the liner. Allow the mixture to sit for 3 minutes and then visually inspect the thermal barrier side of the liner for any signs of liquid passing through the moisture barrier.
- (4) If any liquid passes through, the garment should be removed from service and sent for an advanced inspection. After the evaluation, ensure that the liner is cleaned and allowed to completely dry to remove all traces of the alcohol–tap water mixture.

△ Table A.6.3.5 Advanced Inspection Criteria

Criteria	Coats and Trousers	Hoods/Shrouds	Helmets	Gloves	Footwear	DRD
Soiling	X	X	X	X	X	X
Contamination	X	X	X	X	X	X
Rips, tears, cuts, and abrasion	X	X	X	X	X	X
Damaged or missing hardware or closure system	X	X	X	X	X	
Charring, burn holes, melting	X	X	X	X	X	X
Shrinkage				X		
Material degradation (UV or chemical damage)	X	X	X	X	X	X
Material discoloration	X	X	X	X	X	X
Visibility marking integrity, attachment to garment, reflectivity damage	X		X	X	X	
Loss of face opening elasticity or adjustability		X				
Any damage to the particulate blocking layer (particulate blocking hoods only)		X				
Cracks, dents, abrasions			X		X	
Bubbling, soft spots, warping			X		X	
Damaged or missing components of the suspension and retention systems			X			
Earflaps: rips, tears or cuts, thermal damage (such as charring, burn holes, melting, or discoloration of any layer)			X			
Damaged or missing components of faceshield/goggle system, including discoloration and scratched lenses			X			
Inverted glove liner				X		
Exposed or deformed steel toe, steel midsole, or shank					X	
Loss of water resistance				X	X	
Evaluation of system fit and coat/trouser overlap	X					
Loss of seam integrity	X			X		X
Broken or missing stitches	X	X		X		X
Loss or shifting of liner material	X			X		
Loss of wristlet elasticity, stretching, runs, cuts, or holes	X			X		
Label integrity and legibility	X	X	X	X	X	X
Hook and loop functionality	X		X		X	X
Liner attachment system	X					X
Material elasticity, stretching out of shape		X				
Damage to the impact cap			X			
Loss of flexibility			X			
Punctures, cracking, or splitting		X			X	X
Excessive tread wear					X	
Condition of lining: tears, excessive wear, separation from outer layer					X	

(continues)



△ **Table A.6.3.5** *Continued*

Criteria	Coats and Trousers	Hoods/Shrouds	Helmets	Gloves	Footwear	DRD
Correct assembly and size compatibility of shell, liner, and DRD	X					X
Closure system functionality	X					
Accessories for compliance with 4.2.3	X		X			
Complete liner inspection (Section 6.4)	X					
Delamination as evidenced by separation or peeling of the outer shell (aluminized materials)	X	X	X	X	X	

**A.6.3.5.1(7)** Material discoloration can indicate many types of possible damage, including, but not limited to, dye loss, heat degradation, UV damage, and chemical contamination.

**A.6.3.5.1(9)** Visibility markings can appear to the human eye to be undamaged when actually they have lost much of their ability to reflect. Retroreflective properties can be checked with the following simple flashlight test:

- (1) Stand approximately 12 m (40 ft) from a sample of the trim being tested and a sample of new trim.
- (2) Hold a bright, focused flashlight at eye level, either next to the temple or on the bridge of the nose, and aim the light beam at the samples.
- (3) Compare the brightness of the reflected lights. If the reflected light from the trim being tested is substantially less than the light reflected from the new trim, the trim should be replaced.

This field evaluation test provides effective and timely results while allowing the evaluator to physically view the reflective trim as it is seen by the naked eye.

While this simple test provides a practical evaluation of trim retroreflective performance, it does not evaluate trim fluorescence or mean that the trim will provide adequate fire fighter visibility. Trim can lose fluorescence (daytime visibility) and still remain retroreflective. Trim can also appear to be retroreflective and not have sufficient intensity for nighttime visibility at far distances. Only testing under laboratory conditions can provide an accurate determination of trim visibility properties.

Attention during inspection should be paid to sections that show evidence of damage, abrasion, excessive soiling, or stains/dyscoloration. With proper care, visibility markings on turnout gear can provide long service, often as long as the service life of the ensemble itself.

**A.6.3.5.1(10)** If a label problem is identified, the organization should contact the manufacturer of the ensemble or ensemble element.

**N A.6.3.5.2(5)** Two different test methods are provided for inspection of the particulate-blocking layer in protective hood interface components. Each of these test methods has advantages and disadvantages, and either can be selected.

Section 12.1 provides a standardized means for evaluating damage to the particulate-blocking layer using a light evaluation method. This method is relatively simple and can be applied either by using a clear head form with an internal light source to evaluate the entire hood simultaneously or by using a

pipe section with an internally positioned light source to evaluate selected portions of the hood. Nevertheless, this technique might not be effective for all types of particulate-blocking protective hoods. It might be difficult to identify damaged areas of hoods that have relatively thick or dense layers or are dark in color.

Section 12.2 provides an inspection technique based on the use of smoke directed towards the hood that is clamped onto a modified moisture barrier hydrostatic testing device. The hood is observed for the passage of smoke through the clamped hood inspection area. The test can be performed one of two ways: qualitatively, by simply observing any differences in the amount of smoke coming through the hood; or quantitatively, with the use of a light beam directed across the hood inspection area that measures the interruption of light caused by the passage of smoke. The latter test provides a measurement of light transmission from 0 percent (fully blocked by smoke) to 100 percent (no smoke). Ordinary two-layer knit hoods without particulate-blocking layers generally provide measurements of 20 to 40 percent light transmission. The quantitative method moderately correlates with NFPA 1971's particulate-blocking test used to qualify particulate-blocking protective hoods at the 1 micron particle size. It is important to point out that use of this test will require the hood to be cleaned twice. Hoods must be cleaned prior to the inspection, and they must also be cleaned after the inspection test is applied to remove any residual smoke-generating liquid deposited on the hood as a result of the exposure.

**A.6.3.5.2(10)** If a label problem is identified, the organization should contact the manufacturer of the ensemble or ensemble element.

**A.6.3.5.3(13)** If a label problem is identified, the organization should contact the manufacturer of the ensemble or ensemble element.

**A.6.3.5.4(3)** The watertight integrity of gloves can be evaluated by the following test. A test subject wears lightweight cotton gloves under the gloves being inspected. The test subject then immerses the gloves in water up to the wrist crease, repeatedly flexes his or her hands for 2 minutes, and then takes them out of the water. The test gloves are removed and the cotton gloves examined for signs of watermarks. Gloves showing signs of leakage should be removed from service.

**A.6.3.5.4(8)** If a label problem is identified, the organization should contact the manufacturer of the ensemble or ensemble element.

**A.6.3.5.5(6)** Excessive tread wear significantly reduces traction and safe footing on many surfaces such as wet flooring and roads, roofs, ladder rungs, and apparatus steps and platforms. Inspection of tread wear should focus on the heel and the ball of foot areas since those two areas carry the majority of a fire fighter's body weight and are the most critical in maintaining adequate traction. The organization should consult with the manufacturer and set guidelines for a minimum tread depth that has to be present for footwear to remain in service.

**A.6.3.5.5(10)** If a label problem is identified, the organization should contact the manufacturer of the ensemble or ensemble element.

**A.6.3.5.7(5)** If a label problem is identified, the organization should contact the manufacturer of the ensemble or ensemble element.

**A.6.3.7.1** Organizations should consult with the manufacturer of the ensemble with optional liquid and particulate contamination protection for any additional or specific advanced inspection requirements for this type of ensemble.

**A.6.4.5.1** The ability to inspect the interior sides of the liner for the moisture barrier and thermal barrier can be accommodated by the presence of an inspection opening designed by the manufacturer that is built into the protective element. The location and method for securing this opening will vary with the manufacturer's design. However, the intent of this feature is to permit the organization conducting the inspection to invert the liner so that the interior sides of the moisture barrier and thermal barrier can be readily inspected. If the protective element is not provided with an inspection opening, the organization conducting the complete liner inspection might be required to remove a portion of the seam in the lining to permit opening the lining and allow its inversion for inspecting the interior sides of the moisture barrier and thermal barrier. The procedures used for removing the lining seam should conform to those procedures specified by the manufacturer of the protective element and should account for practices that minimize the damage and allow for ease of reconstructing the liner seam to limit any decrement of protective element performance or integrity.

**Δ A.7.1** The importance of maintaining the cleanliness of ensembles and ensemble elements should not be underestimated. Studies have shown that soiled or contaminated ensembles and ensemble elements are a hazard to fire fighters because soils and contaminants can be flammable, toxic, or carcinogenic. Additionally, soils or contaminants can reduce the protective performance of the ensembles and ensemble elements. Clean ensembles and ensemble elements can last longer and offer emergency responders better protection. Ensembles and ensemble elements should be cleaned whenever they become soiled.

In everyday use, personal protective equipment (PPE) becomes dirty by absorbing sweat from the wearer and soils, soot, and so forth from the outside environment. Cleaning of ensembles and ensemble elements removes those substances. Ensembles and ensemble elements can also become contaminated with other substances, principally hazardous materials, particulates, and body fluids. The removal of these substances is most often referred to by the term *decontamination*. In structural and proximity fire fighting, both general cleaning and decontamination of ensembles and ensemble elements are often necessary.

*Health risks of soiled or contaminated ensembles and ensemble elements.* Soiled or contaminated ensembles and ensemble elements can expose fire fighters to toxins, carcinogens, and other harmful substances that enter the body through ingestion, inhalation, or skin absorption. Repeated small exposures to some contaminants can accumulate within the body over time and cause health problems.

Although great emphasis is placed on safety to avoid injury or inhalation hazards to personnel working on the fireground, many of the contaminants that lead to health risks are being carried away from the fire scene on PPE used by the fire fighter. Structural and proximity fires are increasingly being identified as sources for contamination by products of combustion that are known to include various toxic and carcinogenic chemicals.

Contaminants that a fire fighter could come into contact with can be trapped in the fibers of soiled ensembles and ensemble elements or absorbed into the materials themselves. Contact with the soiled ensembles and ensemble elements increases the risk of hazardous contaminants being introduced into the body through either skin absorption or from contaminants off-gassing into the immediate atmosphere breathed by fire fighters.

Ensembles and ensemble elements contaminated with body fluids present a potential risk of infectious diseases being transmitted to the person coming into contact with the contaminated ensembles or ensemble elements.

Other forms of contaminants include substances such as bulk chemicals, asbestos, and other hazardous substances encountered at the emergency scene.

*Reduced performance hazards of contaminated ensembles and ensemble elements.* When ensembles or ensemble elements become laden with particles and chemicals, other problems are faced in addition to being exposed to toxins, such as the following:

- (1) Soiled ensembles and ensemble elements typically reflect less radiant heat. After materials are saturated with hydrocarbons, they will tend to absorb rather than reflect the radiant heat from the surrounding fire.
- (2) Ensembles and ensemble elements heavily contaminated with hydrocarbons are more likely to conduct electricity, increasing the danger when entering a building or vehicle where wiring can still be live.
- (3) Ensembles and ensemble elements impregnated with oil, grease, and hydrocarbon deposits from soot and smoke can ignite and cause severe burns and injuries, even if the materials are normally flame-resistant.

Even though the number of specialized hazardous materials response teams is growing, individual fire fighters can still encounter various chemicals in their normal fire-fighting activities. Exposures to oils, gasoline, and lubricants can occur around fire station vehicles. During responses, exposures to liquids ranging from pesticides to acids to chemical solvents can occur, knowingly or unknowingly. These contaminants, in addition to being hazardous, can also degrade ensembles and ensemble elements as follows:

- (1) Fabrics and materials can become weakened and tear more easily.
- (2) Thread or seam sealing tape can become loose.
- (3) Water-repelling treatments can be removed.

- (4) Visibility markings can lose reflective properties or markings, becoming less visible.
- (5) Helmet shells, helmet faceshields, or goggles can pit or craze.
- (6) Ensemble and ensemble elements hardware can become corroded.

• **A.7.1.1.1** Verified ISPs are required to go through a third-party verification of their cleaning procedures for garments in order to determine the effectiveness of their cleaning processes. Since the technical committee did not want to deter organizations from cleaning, they purposely did not make this cleaning verification a requirement for organizations cleaning their own gear. However, this validation is the only real assurance that a garment is “clean” as per the parameters established by the standard. Organizations are encouraged to contact verification agencies to have their own cleaning processes go through the same verification; however, the recommended procedures provided in A.7.3.9(5) for garments have been examined in a verification process and are expected to meet the cleaning verification requirements that are applied to a verified ISP.

Although the training for cleaning is only required to be done initially for each new edition of the standard, organizations should work with their training provider to determine if the training needs to be performed more frequently. At a minimum, discussion with the trainer should occur when detergents, chemicals, equipment, processes, or employees managing the training program undergo changes in order to determine if additional training is required.

• **A.7.1.1.3** In most cases, preliminary exposure reduction is a recommended first step for any handling, cleaning, disinfection, or sanitization of protective ensembles or ensemble elements. One exception is where the ensemble and ensemble elements have been exposed to CBRN terrorism agents where the action should be to remove and isolate the clothing as quickly as possible in order to prevent any further spread of contaminants. Certain other highly hazardous contaminants might also pose similar dangers, therefore the actions of the organization should be to have the ensemble and ensemble elements removed and isolated immediately and bagged for later assessment.

Specific procedures for preliminary exposure reduction are provided in Section 7.2. Procedures for preliminary exposure reduction include the isolation, bagging, and separate transport of ensembles and ensemble elements that are contaminated or soiled. In certain rare cases, there might be circumstances where certain steps within the specified preliminary exposure reduction procedures are not appropriate for the circumstances of the event and it is the organization’s responsibility to provide this judgment (e.g., contamination with water-reactive substances or the creation of a hazardous particulate atmosphere from brushing off a highly toxic substance from the exterior of the clothing and equipment). Likewise, there might be circumstances where it is impractical to carry out preliminary exposure reduction on scene and delays might be incurred before the full set of procedures can be undertaken.

• **A.7.1.1.6** In general, dry cleaning is not recommended for cleaning protective ensembles and ensemble elements. Some dry cleaning solvents, particularly perchloroethylene or similar chemicals, used in lieu of water can damage components of the ensembles and ensemble elements. In particular, reflective

trim, moisture barrier seam tape materials, certain helmet materials, and leather gloves can be adversely affected by such solvents. The manufacturer should be consulted prior to performing dry cleaning to confirm that ensembles and ensemble elements will not be damaged. Caution should be exercised in considering any other type of dry cleaning process without fully understanding that the process will not damage the protective ensemble element or its components through one or multiple applications.

• **A.7.1.2** The approaches used for deciding on the handling, cleaning, and disposition of protective ensembles and ensemble elements uses a decision tree involving the highest risk contaminants and soils first and then proceeding to lower risk contaminants and soils. The process is illustrated in Figure 7.1.1.2(a).

*CBRN Exposure.* The first decision involves any exposure to chemical, biological, radiological, or nuclear (CBRN) terrorism agents. The ensemble and ensemble elements are immediately condemned and removed from service, given the high risks associated with CBRN terrorism agents.

*Hazardous Materials Incident Exposure.* The second decision involves the use of fire-fighting protective ensembles and ensemble elements in a hazardous materials incident. It is recognized that fire fighters might sometimes wear their structural or proximity fire-fighting protective ensembles and ensemble elements in response to a hazardous material incident, even if other types of protective clothing might be considered more appropriate for the type of exposure. Hazardous materials incidents typically involve exposure to chemicals or other substances that pose toxic, corrosive, irritating, or sensitizing hazards to the wearer. This type of ensemble or ensemble element use might occur without any fire threat; this section provides for decisions involving exposure during a response to bulk chemicals that occur as the result of a fire-based incident.

For hazardous materials incident exposure, the prescribed action following preliminary exposure reduction, including isolating and bagging the gear, is to have the organization’s hazardous materials team or other qualified experts knowledgeable in hazardous materials assess the exposure to determine if decontamination is needed and is possible. If decontamination is needed, some form of specialized cleaning is required. The recommended decontamination procedures should only be applied if it is understood that it will be effective in removing the hazardous materials contamination or reducing it to a safe level. Otherwise, the ensemble or ensemble elements should be disposed of as contaminated waste.

*Contamination Exposure.* The third decision involves any response where contamination of the protective ensemble or ensemble elements occurs. This decision is broken into a separate set of decisions provided in Figure 7.1.1.2(b) and described in A.7.1.3.

*Soiling Exposure.* If there is no contamination and the ensemble or ensemble element is simply soiled from ordinary dirt, sweat, or other nonhazardous materials, then it is still recommended for the ensemble and ensemble elements to go through preliminary exposure reduction, followed by advanced cleaning, and to be subject to at least a routine inspection.

• **A.7.1.3** The application of the appropriate cleaning, disinfection, or sanitization procedure(s) is dependent on properly classifying the contamination types to which the ensemble or

ensemble elements have been exposed. For this standard, there are four general classifications of contamination.

**Bulk Chemicals.** Exposure to chemicals can occur at any emergency scene, particularly where various types of oils, greases, and lubricants are used. Many residential structural fires include a variety of cleaning agents and other products contained in garages, kitchens, and other portions of a house where direct liquid exposure to the chemical in its bulk form can occur. Structural fires at commercial facilities, particularly those involved in manufacturing, can likewise include a variety of different chemical substances in containers that break open and result in exposure to fire fighters in gas/vapor, liquid, or solid form. Depending on the nature of the specific chemical and its respective hazards, contamination of the ensemble and ensemble elements can occur and remain as persistent contamination that advanced cleaning procedures might be able to remove. Specialized cleaning is often recommended for bulk chemical contamination and could require inquiries to the chemical supplier as well as the manufacturer of the respective protective ensemble or ensemble elements. Depending on the hazards associated with the specific chemicals, the extent of contamination, or the lack of available decontamination procedures, organizations might conclude that the risk for reuse of the ensemble or ensemble elements outweighs any benefits of retaining the clothing even if it appears to be clean and free of contamination.

**Asbestos and Other Designated Hazardous Substances.** Certain types of common contaminants [e.g., asbestos, opioid drugs (fentanyl)] and parasites (e.g., bed bugs) can require specialized cleaning or treatments for their removal from ensembles and ensemble elements. These substances are called out separately from bulk chemical exposures because there is some history and experience for addressing ensembles and ensemble elements contaminated with them. In particular, asbestos warrants special attention because of the direct link between asbestos exposure and mesothelioma, and the elevated risk to fire fighters. Decontamination of ensembles and ensemble elements that have been exposed to fentanyl powders requires use of certain procedures that prevent exposure to fire fighters and others handling the element. Conventional washing of protective ensembles and ensemble elements that have been exposed to bed bugs also will fail to kill all eggs that remain in the clothing. Ensemble and ensemble element exposure to these substances requires special consideration and often entails specialized cleaning procedures or treatments for their removal. Depending on the risk associated with a specific contaminating substance, organizations might conclude that the risk for reuse of the ensemble or ensemble element outweighs any benefits to retaining the ensemble or ensemble element even if it appears to be clean and free of contamination.

**Body Fluids and Other Microbial Contamination.** Body fluids such as blood, vomit, and various secretions are often encountered in providing emergency patient care or rescue of victims at an emergency scene. These fluids must be treated as potentially infectious, therefore ensembles and ensemble elements contaminated with body fluids must be subject to sanitization or disinfection, where disinfection represents a greater efficiency in removing potentially infectious microorganisms. Other biological contaminants can include methicillin-resistant *Staphylococcus aureus* (MRSA) and *Clostridium difficile* (C. difficile) from medical victim contact and *Escherichia coli* (E. coli) from flood water contact. These contaminants require

disinfection or sanitization of ensembles and ensemble elements to reduce the microbial threat where exposure has occurred. Disinfection or sanitization might precede advanced cleaning or be part of the advanced cleaning process since soils associated with many body fluids must also be removed. It is important to recognize that disinfection or sanitization generally only affects the viability of the microbial contamination and might not remove other associated soils such as dried blood, body fluids, or other liquids/solids in which the microbial contamination is found.

**Products of Combustion.** Generally, all fires where entry is made while wearing self-contained breathing apparatus (SCBA) will expose ensembles and ensemble elements to products of combustion. The smoke particles and fire gases easily penetrate and contaminate clothing. Depending on the length of exposure and degree to which fire fighters are exposed, the levels of contamination from products of combustion will vary but will always require advanced cleaning. Preliminary exposure reduction is undertaken to remove some forms of surface contamination as well as to minimize the transfer of exterior contaminants to the fire fighter or other surfaces such as apparatus seats and fire station work/living areas prior to advanced cleaning.

**A.7.1.3.4.1** Figure 7.1.1.2(b) shows the application of preliminary exposure reduction if protective ensembles or ensemble elements are suspected of being contaminated by body fluids. Footnote (b) states body fluid contamination also includes other microbial contamination. Other microbial contamination can be interpreted to include airborne pathogenic viruses (such as SARS-CoV-2, which is responsible for COVID-19); however, the preliminary exposure reduction techniques described in Section 7.2 and the related annex sections have not been verified for sanitization, disinfection, or inactivation of airborne pathogenic viruses on protective ensembles and ensemble elements under field conditions and should not be relied upon for these purposes unless specific evidence is provided on the efficacy of specific techniques or cleaning agents applied against contamination caused by airborne pathogenic viruses. Therefore, preliminary exposure reduction should not be considered to be a form of field biological disinfection or sanitization for continued use of protective ensembles or ensemble elements unless the subject techniques have been demonstrated to be effective for reducing microbial loads on protective ensembles or ensemble element materials to acceptable safe levels established by the U.S. Environmental Protection Agency or Centers for Disease Control and Prevention (CDC) and are further shown not to compromise the performance properties of the protective ensemble or ensemble element or create potential skin contact or other health issues associated with residual cleaning agent, disinfectant, or sanitizer remaining in the protective ensemble or ensemble element.

**A.7.1.3.4.2.3** Some forms of biological contamination can require cleaning processes with higher wash temperatures than are permitted for advanced cleaning of ensembles and ensemble elements. If higher wash temperatures are used, see A.7.3.9(4) for additional information on potential impacts of this process.

**A.7.1.3.5.1** It is recognized that it might not always be practical for organizations to carry out preliminary exposure reduction on-scene because of personnel constraints, lack of on-scene resources, availability of spare gear, the weather, and

other operational factors. Nevertheless, it is important that organizations implement some form of preliminary exposure reduction procedure as soon as is practically possible, particularly following any event where ensembles or ensemble elements are contaminated.

Organizations should review and revise their policies and procedures to minimize opportunities for cross contamination of apparatus, personal vehicles, and fire stations.

**N A.7.1.3.5.2** It is recognized that it might not always be possible for organizations to remove soiled or contaminated ensembles or ensemble elements from service immediately following an incident for advanced cleaning. This is not intended to change the fact that advanced cleaning should be applied whenever protective ensembles or ensemble elements are soiled and contaminated. It is important that organizations implement advanced cleaning as soon as possible following any event where ensembles or ensemble elements are soiled or contaminated.

Organizations should review and revise their policies and procedures to minimize the number of incidents where soiled or contaminated ensembles or ensemble elements remain in service. They should also review and revise their procedures to reduce the amount of time soiled or contaminated ensembles or ensemble elements remain in service, in those rare incidents, before receiving advanced cleaning. The goal is to eliminate the number of times and the amount of time contaminated ensembles and ensemble elements are left in service.

In many cases, this will fundamentally change the way fire departments manage their on-scene and post-scene operations. Organizations and fire fighters must understand that the longer soiled or contaminated PPE remains in service, the longer fire fighters are exposed to carcinogens and other health hazards. This exposure includes direct contact as well as off-gassing.

**N A.7.2** Preliminary exposure reduction is not considered by itself to be a complete cleaning of ensembles or ensemble elements. Rather, it is intended to reduce the exposure of fire fighters to soils and contaminants that arise during structural or proximity fires or other emergency response events. Preliminary exposure reduction also aids in minimizing the transfer of soils and contaminants from the emergency scene to the apparatus, station, and personal vehicles. Other forms of cleaning, such as advanced or specialized cleaning, are required to provide full cleaning of the ensemble or ensemble elements.

**N A.7.2.1.1** Preliminary exposure reduction is an essential first step in minimizing cross contamination preceding the cleaning of ensembles or ensemble elements as specified in 7.1.1.2 and as shown in Figure 7.1.1.2(a) and Figure 7.1.1.2(b).

**A.7.2.1.2** Preliminary exposure reduction is an attempt to remove some exterior soiling and contamination from ensembles and ensemble elements that is performed by the end user to minimize transfer of soil and contaminants outside of the incident scene. Whenever possible, preliminary exposure reduction should be conducted as personnel exit the emergency scene and before entering the rehabilitation area. While it is possible to conduct dry mitigation without the elements being taken out of service, wet mitigation might require protective elements to be removed because they are wetted. While the selected procedures for preliminary exposure reduction might

not result in the elements being taken out of service, a determination by the organization might be made that the elements be isolated and bagged if determined to be contaminated and warrant more extensive cleaning.

Some organizations might consider having spare gear or other spare clothing, such as disposable clothing, available for members to wear until the members can shower and change into clean clothing.

It is recognized that it might not always be practical for organizations to carry out preliminary exposure reduction on-scene because of personnel constraints, lack of on-scene resources, availability of spare gear, the weather, and other operational factors. Nevertheless, it is important that organizations implement some form of preliminary exposure reduction procedure as soon as is practically possible, particularly following any event where ensembles or ensemble elements are contaminated.

Organizations should review and revise their policies and procedures to minimize opportunities for cross contamination of apparatus, personal vehicles, and fire stations.

**N A.7.2.2** See A.7.1.3.4.1.

**A.7.2.2.1** Preliminary exposure reduction after the termination of an incident can remove substantial amounts of surface contaminants before they have a chance to set in and might limit the transfer of contaminants to apparatus, personal vehicles, and stations. Many of the contaminants that can cause damage to visibility markings and other materials and components of ensembles or ensemble elements also can be removed if preliminary exposure reduction is done as soon as possible after exposure. It is recognized that is not always practical for organizations to carry out preliminary exposure reduction on scene because of constraints in personnel, on-scene resources, availability of spare gear, weather, and other operational factors. Nevertheless, it is important that organizations implement some form of preliminary exposure reduction procedures as soon as practically possible, particularly following any event where ensembles or ensemble elements are contaminated.

Use of a portable decontamination shower unit that conforms to the requirements in ANSI/ISEA 113, *American National Standard for Fixed and Portable Decontamination Shower Units*, is one means for providing wet mitigation as part of preliminary exposure reduction.

**N A.7.2.2.2** The purpose of remaining on air is to minimize the end user's exposure to products of combustion that might off-gas from the ensemble or ensemble elements following contaminant exposure during a structural fire and to help the end user avoid breathing in any particulates that might be dislodged from the ensemble or ensemble elements during dry mitigation.

**N A.7.2.2.4** The decision between dry and wet mitigation will depend on the resources available to the organization and the conditions at the emergency scene or other location. Work by the Illinois Fire Service Institute under an Assistance to Firefighters Research Grant from the U.S. Department of Homeland Security has shown that wet mitigation techniques are more effective in removing surface contamination as compared to dry mitigation techniques. Wet mitigation techniques remove a significant amount of products of combustion whereas dry mitigation techniques only remove a portion of

such contamination. Techniques involving blowing air onto ensembles or ensemble elements, such as from a leaf blower, should be avoided because they are minimally effective and might only redistribute contamination at the emergency scene and create inhalation hazards for unprotected personnel (Fent, et. al.).

**N A.7.2.2.4.1** Dry mitigation techniques are best achieved with a soft bristle brush starting at the top of the end user's ensemble or ensemble element and working downward.

**N A.7.2.2.4.2** There are several means by which wet mitigation techniques can be carried out. One method is to use a reducer from the apparatus pump panel to supply a small hose line, such as a forestry hose or a garden hose with an adjustable nozzle, at low pressure and volume. Caution should be applied when using ordinary fire hoses and nozzles for this technique where the lowest possible flow rate is used. Most departments might have a "booster line" or "trash line" that is usually  $\frac{3}{4}$  in. or 1 in. in diameter than can be applied at a low pressure less than 30 psi. Portable decontamination showers that conform to ANSI/ISEA 113, *American National Standard for Fixed and Portable Decontamination Shower Units*, can also be used and assist where weather, modesty, or other issues might occur.

The process of wet mitigation should start with spray at the top of the user's ensemble or ensemble element, rinsing downward. Where necessary, a soft bristle brush might be used to gently scrub the ensemble or ensemble elements. It is important that the spray be light, that it doesn't soak through the clothing, and that it can be applied over the entire fire fighter, as the primary purpose of this mitigation technique is to remove surface contamination. Wet mitigation techniques cannot remove interior layer soiling or contamination.

It is further recommended that a mild detergent be used as an aid in wet mitigation where the surfactant in the detergent is helpful for removing exterior soils. Where a mild detergent is used, it should be followed by gentle rinsing of the ensemble or ensemble elements.

Organizations performing wet mitigation techniques should take into consideration the runoff of any contaminated rinse water to minimize the spread of contamination to the environment.

**N A.7.2.2.5** It is recognized that it might not always be practical for organizations to carry out preliminary exposure reduction on-scene because of personnel constraints, lack of on-scene resources, availability of spare gear, the weather, and other operational factors. Nevertheless, it is important that organizations implement some form of preliminary exposure reduction procedure as soon as is practically possible, particularly following any event where ensembles or ensemble elements are contaminated.

Organizations should review and revise their policies and procedures to minimize opportunities for cross contamination of apparatus, personal vehicles, and fire stations.

The removal of ensembles or ensemble elements at the scene might require additional clothing to be present, particularly under inclement or cold weather conditions. Portable facilities might be required for end users to change. Portable decontamination showers conforming to ANSI/ISEA 113, *American National Standard for Fixed and Portable Decontamination Shower Units*, can be set up at the scene in a relatively short period of time and require limited resources for provided in

protection from weather and modesty to fire fighters. In addition, it is recommended that personnel use disposable wet wipes to clean portions of their face and skin when known to be directly exposed to contaminants, change into a clean station/work uniform, and take a shower as soon as possible.

For isolation of ensembles and ensemble elements, airtight protective containers or bags should be used to minimize cross contamination. Examples include disposable, heavy-duty polyethylene bags or sealable plastic cases, which are cleanable. If a plastic bag is used, it is recommended that the bag be clear to ensure that the contents of the bag can be readily identified. Relatively thick plastic bags, at least 2 mils in thickness, are recommended to resist punctures. Ensembles or ensemble elements should not be transported from the incident scene in the passenger areas of apparatus or personal vehicles. This reduces further exposure of personnel to contaminated ensembles and ensemble elements and also reduces cross contamination of apparatus or personal vehicles.

If the protective ensemble or ensemble elements are wet, the protective ensemble or ensemble elements must be removed as soon as possible following transport from the fire or other emergency scene since ensembles and ensemble elements that remain wet under closed conditions can result in the growth of damaging mold and mildew. It is further important that, following their transport, protective ensembles and ensemble elements be stored under conditions where they can dry until appropriate cleaning procedures can be conducted as specified in Chapter 7.

**N A.7.2.4** The manufacturer's guidelines for the proper cleaning of faceshields, flip-downs, or goggles should be followed. Most manufacturers list specific products that will clean these components without causing damage. For example, repeatedly using ammonia-based window cleaner will eventually cause fogging that will decrease visibility.

**N A.7.3.1.3** To perform advanced cleaning, the organization must be a manufacturer-trained organization. The training required to become a manufacturer-trained organization is specified in 4.2.4.5.

**Δ A.7.3.3** Advanced cleaning is a thorough cleaning of ensembles and ensemble elements accomplished by washing them with cleaning agents. Advanced cleaning is prescribed for ensembles and ensemble elements that are soiled or contaminated, including those that have been subject to ordinary wear without contamination, those that have been contaminated in structural or proximity fire fighting by products of combustion, or those that have been exposed to blood and body fluids. Where highly hazardous or other designated substances are involved, specialized cleaning might be needed.

Specialized cleaning differs from advanced cleaning in that an assessment of the contamination by an individual knowledgeable in the cleaning of fire-fighting protective ensembles and ensemble elements is needed for determining what type of cleaning, if any, is appropriate.

Advanced cleaning requires elements to be temporarily taken out of service. Advanced cleaning can be accomplished by hand washing in a utility sink or by machine washing, depending on the ensemble or ensemble element. Hand washing is not permitted for ensemble or ensemble elements, except for proximity fire-fighting garment outer shells and other radiant reflective components, because machine washing

can cause damage to the aluminized surfaces of these materials.

Soiling and contamination are not always visible and can be difficult to observe on darkly colored materials. In addition, ensembles and ensemble elements can be contaminated with persistent fire gases and other hazardous substances, resulting in ensembles and ensemble elements that are unsafe for use. Ensembles and ensemble elements that have not been cleaned and appear to be unsoiled have been shown to contain numerous fire gas chemicals, including carcinogenic polynuclear aromatic compounds. Periodic cleaning is required to avoid use of ensembles and ensemble elements that could be contaminated without visible evidence of soiling.

It is the intent of this standard that ensembles and ensemble elements receive advanced cleaning whenever they are soiled or contaminated. This is in addition to the being subjected to advanced cleaning twice a year (see 7.3.4 and A.7.3.4).

It is recognized that it might not always be practical for organizations to remove soiled or contaminated ensembles or ensemble elements from service immediately following an incident for advanced cleaning. This is not intended to change the fact that advanced cleaning should be applied whenever protective ensembles or ensemble elements are soiled and contaminated. It is important that organizations implement advanced cleaning as soon as is practically possible following any event where ensembles or ensemble elements are soiled or contaminated.

Organizations should review and revise their procedures to reduce the amount of time soiled or contaminated ensembles or ensemble elements remain in service, in those rare incidents, before receiving advanced cleaning. The goal is to eliminate the number of times and the amount of time contaminated ensembles and ensemble elements are left in service.

In many cases, this will fundamentally change the way fire departments manage their on-scene and post-scene operations. Organizations and fire fighters must understand that the longer soiled or contaminated PPE remains in service, the longer fire fighters are exposed to carcinogens and other health hazards. This exposure includes direct contact as well as off-gassing.

**N A.7.3.3.2** Organizations should consult with ISPs, manufacturers verified in cleaning, and verified cleaners for guidance on appropriate advanced cleaning procedures that are also effective in sanitization and disinfection.

**N A.7.3.3.3** Normally the presence of biological contaminants warrants the application of sanitization or disinfection in accordance with Section 7.4 that is followed by either advanced cleaning or specialized cleaning. As one example, in the case of bed bug contamination, the application of disinfection or sanitization may not be effective. Instead, specialized cleaning in the form of applying extended freezing temperatures or hotter wash temperatures than permitted by advanced cleaning is required (see A.7.5.3). It is possible that other unique forms of biological contamination can also require specialized cleaning only with the application of disinfection and sanitization.

**N A.7.3.4** This requirement is not intended to change the fact that advanced cleaning should be applied whenever protective ensembles or ensemble elements are soiled and contaminated. Instead, it is intended to ensure that worn and used clothing is

subjected to advanced cleaning at least every six months. One of those advanced cleanings should be in conjunction with an advanced inspection.

**Δ A.7.3.5** Machine cleaning using a front-loading washer/extractor is the most effective method for cleaning ensembles and ensemble elements such as structural fire-fighting coats, trousers, coveralls, and hoods. It is the most effective means of loosening and removing dirt, soot, and other debris. Front-loading washer/extractors are the appropriate machine type for protective ensembles and ensemble elements.

Front-loading washer/extractors have a door on the front of the machine through which garments are loaded. They clean by lifting garments out of the water and gently dropping them back into the water. These units provide better mechanical action because of the size and type of rotation, as well as the degree of extraction. They have various capacities and are designed to handle heavy loads of bulky items and also to save water and energy.

The capacity of a washer/extractor is important for several reasons, including the following:

- (1) Washer/extractors that are overloaded do not clean effectively because there is not enough movement of the protective elements to provide for mechanical action.
- (2) Washer/extractors that are underloaded do not clean effectively because the wash articles do not make sufficient contact with mechanical action.
- (3) Large washer/extractors require more water and energy and also output a lot of water during the extraction discharge steps of the washing process.

A washer/extractor with a minimum load capacity of 13.6 kg (30 lb) and a minimum volumetric capacity of 0.11 m<sup>3</sup> (4.0 ft<sup>3</sup>) is recommended. However, the capacity selection for the wash can be increased or decreased depending on the expected throughput of garments and the frequency of advanced cleaning. Further information on washer/extractor loading is provided in A.7.3.9(1).

It is very important for machine operators to ensure correct water temperatures and proper detergent selection and to adjust the g-forces of the spinning/extraction cycle. Careful adherence to manufacturers' recommendations of cleaning processes has a significant impact on cleaning thoroughness and maintenance of protection factors inherent in each element, as well as extending the life expectancy of elements.

When possible, organizations should provide a washer/extractor(s) for the sole purpose of cleaning protective ensembles and ensemble elements.

**N A.7.3.5(2)** Preliminary research suggests that excessive g-forces created by washing machine drums that spin at high revolutions per minute (RPMs) can damage protective garments. The type and severity of damage will depend on the g-forces created, exposure time, number of exposures, condition of the ensemble or ensemble element, and materials used to construct the ensemble or ensemble element. Thermal and moisture barriers are the most vulnerable. Thermal barriers can hold several times their weight in water; extraction at high RPMs creates high g-forces, resulting in the shifting of nonwoven insulating materials. Moisture barrier materials and seams are designed to impede the flow of water; extraction at high RPMs can severely damage moisture barriers and moisture barrier seams as water pushes against the barriers in an attempt

to escape toward the outer perimeter of the drum. A vast majority of ISPs are monitoring extraction RPMs and have adjusted their commercial machines to create less than 100 G when cleaning all protective ensembles and ensemble elements. End users should make every effort to control and lower the RPMs of laundering machines used for protective ensemble and ensemble elements to preserve their integrity and increase their longevity.

**N A.7.3.6** Top-loading machines are similar to those used in most homes. Many use a center post agitator to whisk water through the fibers of garments. There are also high efficiency (HE) top-loading machines that do not have an agitator designed to clean multiple garments of minimum bulk. As a result of the center post agitation in machines that incorporate that feature, it is generally accepted that top-loading machines are more damaging to ensembles and ensemble elements than front-loading machines. Furthermore, many top-loading machines are unable to precisely control the temperatures for individual cycle steps, and HE top-loading machines generally lack sufficient rinsing capability for advanced cleaning of garments. Therefore, top-loading, agitating machines have the potential to reduce the longevity of garments due to mechanical damage and could be less effective in cleaning protective garments.

**N A.7.3.6.1** Some manufacturers might maintain lists of advanced cleaning processes, equipment, and detergents.

**N A.7.3.7.2** The pH for the product can be indicated on the product (detergent) container and should be the pH for the product in an undiluted form if it is a liquid. If the detergent is a powder, the pH will be reported at a specific concentration of the solid on a weight basis in water. If the pH is not listed on the product container, then the safety data sheet (SDS) should be requested from the product supplier. Most suppliers will normally provide the SDS for their respective products as part of the shipment, and it might also be possible to obtain a copy of the SDS online from the supplier's website.

The pH for the product is typically listed in Section 9 of the SDS for the product's physical and chemical properties.

The selection of the detergent should include a consideration of several factors in addition to the pH range. Foremost among these is demonstration by the supplier that the detergent is safe to use with fire fighter protective clothing. This demonstration consists of the following two parts:

- (1) The effectiveness of the detergent in removing soils and other contaminants as indicated later in this section
- (2) The impact of the detergent through multiple washings on the protective element as described in A.7.3.7.3

This information might be available from the supplier of the detergent, the manufacturer of the protective element, or the fabric suppliers. If there is uncertainty about a particular detergent or cleaning agent, the manufacturer of the protective element should be contacted.

Organizations should be cautious about detergent or chemical suppliers that offer several different chemicals for cleaning protective elements. Many chemical suppliers will provide the organization with an automated dispenser that can feed liquid chemicals into the washer/extractor at no cost, on the requirement that chemicals are purchased from that supplier. Certain types of chemicals, such as alkali builders and sours, should be avoided. Alkali builders are used to significantly increase the

pH of the wash water for enhancing the cleaning performance of certain detergents. These chemicals typically have pH values that are greater than 10.5. When alkali builders are used, the pH is usually brought to a lower level using a "sour," an acid-based agent used to bring the wash water back to a neutral pH. Sour cleaning agents are added toward the end of the wash formulation and almost always have pH values much lower than 6.0. The combination of alkali builders and sours is most often used in institutional laundering facilities but is not appropriate for protective elements unless the manufacturer of the respective protective element has indicated that these types of products can be used safely.

In general, mild domestic laundry detergents can be used if applied with the instructions provided for the laundry in terms of the amount of detergent added for the wash water volume used in the suds (detergent addition step) for the specific washing machine or washer/extractor. A single detergent can be viable for washing both the shell and liners for structural fire-fighting protective garments; however, some suppliers might offer specialty detergents that have been formulated for either heavier duty cleaning of outer shells or gentler cleaning of linings. In addition, spot treatment agents are usually required for removal of specific heavy soiling and some common fire-ground contaminants.

**N A.7.3.7.3** Cleaning processing can have different effects on the performance properties of protective ensembles or ensemble elements, especially when repeated multiple times over the life cycle of the ensemble or ensemble element. The effects of the cleaning agent or cleaning process should be judged on the basis of tests performed on representative material samples following several cleaning cycles (washing and drying). The samples should be subjected to at least 25 cleaning cycles; however, organizations might want to demonstrate effects after as many as 40 cleaning cycles.

Ideally, ensembles and ensemble elements should be evaluated for each of the performance properties listed in NFPA 1971; however, key properties can be selected. Table A.7.3.7.3 provides a list of recommended key properties for the evaluation of the impact of cleaning procedures on garment elements. One approach for evaluating these properties is to construct large panels of the composites, with finished edges and including seams and other components of interest used in representative protective clothing, and subject these samples to the cleaning process multiple times. A panel size of 66 cm<sup>2</sup> (26 in.<sup>2</sup>) has been found useful for this type of testing.

Other properties that are of interest to the organization can be evaluated, including, but not limited to, the following:

- (1) Composite weight
- (2) Composite thickness
- (3) Composite total heat loss (breathability)
- (4) Outer shell colorfastness to washing
- (5) Outer shell colorfastness to light exposure
- (6) Outer shell or thermal barrier abrasion resistance

The effects of cleaning properties are evaluated by comparing the measured property after washing with the same property measured for new material. It is important to review both the after-cleaning level and the change for the measured property. Properties should remain at or above the minimum performance requirements established in NFPA 1971. However, it should be recognized that some properties, such as composite total heat loss and individual layer tear resistance might be



reduced and fall below initial NFPA 1971 minimum performance requirements during the service life of the garment. These criteria only pertain to ensembles and ensemble elements when new; therefore, experienced individuals within the organization should make a determination on whether diminished performance represents a safety hazard to the wearer.

It is also important to take note of large changes in clothing material properties, even if the results show compliant performance. For example, the tear strength of a material can be measured at a level of 11.4 kg (25 lb) before cleaning and then 10 kg (22 lb) after several cycles, whereas a different material could begin at 18.2 kg (40 lb) and drop to 11.4 kg (25 lb) after the same number of cleaning cycles. This particular case points out that one material might be more susceptible to damage during cleaning.

It is also possible for some measured properties to increase after multiple cleaning cycles. For example, thermal insulation as measured in the thermal protective performance test often improves after cleaning because the thickness (or loft) of the materials increases. Conversely, the total heat loss (THL) value of the same ensemble can decrease as a result of cleaning.

In evaluating the effects of cleaning agents or cleaning procedures on ensembles and ensemble elements, it is important to realize that applying multiple cleaning cycles does not simulate its use. Cleaning is but one factor in the wear of protective ensemble and ensemble elements. Cleaning, when properly applied, might also extend the life of the ensemble and ensemble element.

**N A.7.3.7.4** Organizations should be aware that cleaning of protective equipment is a complicated process and that there is no guarantee that the protective elements will be free from

contamination after being subjected to an appropriate advanced or specialized cleaning procedure.

*Testing for Cleaning Effectiveness.* While the purpose of cleaning is to remove all contamination from an ensemble or ensemble element, cleaning processes are not always 100 percent effective in removing all contamination. The actual success of a cleaning process can be determined only by measuring the concentration of the contaminant(s) in the element before and after the selected process. The majority of tests that can be applied for measuring the concentration of contamination in the ensemble or ensemble element require destructive sampling of the ensemble or ensemble element that could render it unusable or nonrepairable. Furthermore, many test methods require only small portions of material for analysis; therefore, there is a lack of certainty that the swatches or pieces of material analyzed are representative of the entire ensemble or ensemble element. In addition, if destructive testing of one or more ensembles or ensemble elements is applied, then assumptions about other untested ensembles or ensemble elements have to be made, which might not be verifiable.

If testing is performed on a contaminated ensemble or ensemble element, it is also necessary to test unaffected elements in order to get a baseline on chemicals that might already be present in the clothing so that an adequate comparison of cleaned and uncleaned clothing can be made to determine the effectiveness of the cleaning process. When noncontaminated elements are selected for testing, they should be selected in such a fashion as to provide a similar age and level of use and prior cleaning for establishing an appropriate baseline. While an analysis of the rinse water or other extract from a cleaning process can provide some information, the sole evaluation of contamination levels in rinse water is not an appropriate measure of effectiveness. Claims for ensembles or

**N Table A.7.3.7.3 Recommended Test Methods in NFPA 1971 for Evaluating Effects of Advanced Cleaning Procedures on Garment Performance Properties**

Performance Property	Test Method (in NFPA 1971)	Type of Sample(s)	Specimens Required*
Thermal protective performance (TPP)	Section 8.10	Composite	Three 150 mm (6 in.) squares
Flame resistance	Section 8.2	Outer shell, moisture barrier, thermal barrier	Five 75 mm × 305 mm (3 in. × 12 in.) rectangles (in each material direction)
Tear resistance	Section 8.12	Outer shell, moisture barrier, thermal barrier	Five 75 mm × 150 mm (3 in. × 6 in.) rectangles (in each material direction)
Breaking strength	Section 8.50	Outer shell	Five 100 mm × 200 mm (4 in. × 8 in.) rectangles (in each material direction)
Seam-breaking strength	Section 8.14	Major outer shell, moisture barrier, thermal barrier	Five 100 mm × 200 mm (4 in. × 8 in.) rectangles where seam bisects long dimension
Water absorption resistance	Section 8.25	Outer shell	Three 200 mm (8 in.) squares
Cleaning shrinkage resistance	Section 8.24	Outer shell, moisture barrier, thermal barrier	Five 375 mm (15 in.) squares
Liquid penetration resistance—Fuel H	Section 8.27	Moisture barrier seams	Three 75 mm (3 in.) squares
Viral penetration resistance	Section 8.28	Moisture barrier seams	Four 75 mm (3 in.) squares
Retroreflectivity and fluorescence	Section 8.45	Trim sections	Four 305 mm (12 in.) lengths

\*Either specimens removed from garment element or representative prepared material samples.

ensemble elements being contaminant-free based on statements from any organization or facility or based on the use of specific cleaning products or processes should be viewed with caution unless detailed information demonstrating effectiveness in removing specific contaminants from relevant fire fighter ensembles or ensemble elements is provided.

*General Procedures for Clothing Contamination Testing.* Procedures used for measuring contamination levels should be specific for the contaminant(s), if known. Useful analytical procedures for measuring levels of a broad range of semivolatile organic chemicals in materials are found in the following sections provided in EPA SW-846, *Test Methods for Evaluating Solid Waste, Physical/Chemical Methods*: Method 3540C, "Soxhlet Extraction" and Method 8270D, "Semivolatile Organic Compounds by Gas Chromatography/Mass Spectrometry (GC/MS)."

These procedures involve extracting a small piece of fabric in a solvent such as methylene chloride and analyzing the extract solution using gas chromatography in conjunction with mass spectrometry. The gas chromatography separates chemical contaminants and quantifies their amount, while the mass spectrometry identifies the separate chemicals. It is important to note that these procedures only target certain classes of common chemical contaminants such as polynuclear aromatic hydrocarbons, phthalates, certain substituted phenols, and other low volatility organic compounds. Different extraction and analysis methods have to be used for other contamination substances such as brominated fire retardant chemicals and substituted dioxins.

Similar analytical procedures for measuring levels of inorganic chemicals (e.g., heavy metal contaminants like arsenic, chromium, and lead) in materials are found in the following sections provided in EPA SW-846, *Test Methods for Evaluating Solid Waste, Physical/Chemical Methods*: Method 3015A, "Microwave Assisted Acid Digestion of Aqueous Samples and Extracts," and Method 6010D, "Inductively Coupled Plasma-Atomic Emission Spectrometry." These procedures also involve analysis of a small material specimen. The specimen is digested in nitric acid and then treated with 50 percent hydrogen peroxide. The solution of the digested specimen is then diluted for analysis by atomic absorption or ion coupled plasma-atomic spectroscopy to identify and determine the amount of different inorganic substances.

Most tests for evaluating contamination levels of protective ensembles or ensemble elements will yield results that are reported in mass of contaminant per unit mass of the material, such as milligrams of contaminant per kilogram of material (mg/kg), which is equivalent to parts per million (ppm). In other cases, test results might be reported in the mass of contaminant per unit area of material, such as micrograms per square centimeter of material ( $\mu\text{g}/\text{cm}^2$ ). These types of measurements provide a quantity of contamination that can be extrapolated to the entire item, knowing its overall weight or surface area; however, that extrapolation assumes that the contamination is uniformly spread over the entire ensemble or ensemble element. This is generally not a valid assumption since contamination varies across the ensemble or ensemble element.

*Establishment of the Testing Approach.* Because these procedures are sensitive for quantifying many forms of contamination, any testing for measuring contamination levels should involve control tests. Control tests are separate measurements used to

determine background contamination that might be present in the material or in residue left from the cleaning agents or cleaning procedures. Failure to consider such chemicals can interfere with the accuracy of measurements for actual contaminants. In general, the following control tests are needed:

- (1) A test of the same material being analyzed without the contaminant present (e.g., material taken from PPE with a similar history but unexposed to the contaminants)
- (2) A test of the same material that is not contaminated after washing that has been subjected to the cleaning process (e.g., a test on a piece of new material that has been cleaned using the subject cleaning agent and procedures)

The levels of residual contaminants from these control tests should be subtracted from the after-cleaning samples. The residual contamination from the first control test should be subtracted from the before-cleaning samples. Decontamination effectiveness can be determined by calculating the proportion of contaminant removed using the following equation:

[A.7.3.7.4]

$$\text{Percent decontamination efficiency} = \frac{\text{Initial level of } C - \text{Final level of } C}{\text{Initial level of } C} \times 100$$

where:

$C$  = contaminant

The decontamination effectiveness will vary with each contaminant because some contaminants can be removed more easily than others, given differences in the properties of the contaminant and the properties of the contaminated element materials. For example, chemicals such as hexane and benzene that evaporate easily will usually be removed easily compared with nonvolatile (nonevaporating) chemicals found in tars and oily chemicals.

*Interpretation of Test Results.* The remaining level of contaminant in a protective ensembles or ensemble element can be used to determine the potential risk to the wearer. However, there are no established safe levels of residual concentration levels for most contaminants. The decision to reuse a protective element based on known, measured levels of contamination should be undertaken by a trained professional familiar with the properties and hazards of the contaminant. Any uncertainty of the risk presented by residual contamination or of acceptable levels for continued use can be a cause for retirement and disposal of the protective item.

The procedures for measuring contamination levels in protective ensembles or ensemble elements are usually destructive in that they require that a specimen be taken from the item and subjected to extraction or digestion with a solvent. This requirement, in addition to the expense of the analytical testing, can make the decision to investigate contamination levels in protective ensembles or ensemble elements cost prohibitive.

Specimens of protective ensembles or ensemble elements taken for determination of contamination levels cannot be representative for all areas of the item being sampled. For example, a specimen taken from the pocket of a coat will not reflect the contamination level for the back of the coat or the bottom of trousers. In addition, sampling of one protective ensemble or ensemble element will not be representative of all ensembles or ensemble elements from a certain group that are

or are suspected of being contaminated. Contamination levels for different protective ensembles or ensemble elements of the same type depend on the type of exposure, the condition of the protective element, and the care provided to the item.

Concerns over protective ensemble or ensemble element contamination can arise from a single incident involving a contamination event or can be an ongoing consideration as contaminants from routine situations accumulate in the ensemble(s) or ensemble element(s). Organizations can periodically sample ensembles and ensemble elements to determine the effectiveness of cleaning processes in removing harmful contaminants, but they should understand the limitations of the approach — specifically that sampling cannot be representative of all the protective ensembles and ensemble elements in use.

Further details about this information are provided in the report for the U.S. Fire Administration (USFA), “Research, Testing, and Analysis on the Decontamination of Fire Fighting Protective Clothing and Equipment.” A synopsis of the USFA report is provided in ASTM STP1237, *Performance of Protective Clothing*.

*Overall Considerations for Contamination Testing.* While testing for determining contamination in exposed or cleaned protective elements can be useful, it must be carefully performed by qualified laboratories with the results interpreted by knowledgeable individuals to provide an accurate assessment of cleaning effectiveness and any hazards associated with the reuse of protective clothing. This testing is generally expensive, is destructive of the element being tested, and takes some to have performed. Any decision to perform testing on contaminated clothing should weigh the costs for replacing the clothing versus the cost of testing and destruction of clothing items through testing.

**N A.7.3.8** Universal precautions, normally applied for handling items potentially exposed to blood-borne pathogens, involve the assumption that all contamination is potentially harmful and that individuals handling the items need to wear appropriate PPE and apply appropriate hygiene to avoid accidental contact with contaminated ensembles or ensemble elements. Recommended PPE includes examination gloves, an apron and protective sleeves or coveralls, and a pair of safety glasses or goggles.

**A.7.3.9(1)** Proper load size is essential for effective cleaning. An overloaded washer prevents the wetted load from dropping during the washing process from an 11 o’clock to a 5 o’clock drop in a clockwise wash rotation. Overloading occurs when this drop of the wash load does not happen. In addition, full loads are best for washing as the agitation and cleaning are most efficient with full loads. Therefore, it is also important to avoid under-loading the washer/extractor.

The capacity of a washer/extractor is provided both in the weight of the load, usually reported in pounds, and the overall volume, usually reported in cubic feet, of the basket. As a rule of thumb, one cubic foot of washer/extractor basket allows a capacity of two garment shells or liners. For example, a 30 pound washer/extractor has a basket volume of 4.1 cubic feet. Thus, a washer/extractor with this capacity would fit four pieces. Similarly, a 60 pound washer/extractor with a 9.0 cubic foot basket would fit nine pieces. Where there is a fractional amount of cubic feet in the washer/extractor capability, it is

recommended to round up to get a whole number of garment pieces.

**A.7.3.9(2)** It is recommended that heavily soiled structural fire-fighting garments be soaked according to the detergent manufacturer’s instructions. The garment should be removed and the soak water should be drained. If necessary, a soft bristle brush should be used to gently scrub those portions of the garment outer shell that have the greatest soiling. Alternatively, specific formulations for washer/extractors can include presoak steps at the beginning of the wash cycle.

Proximity garment outer shells should not be soaked, scrubbed, or brushed. Use a soft cloth or sponge when cleaning proximity garments.

**A.7.3.9(4)** At the time this edition was prepared, the technical committee recognized that, depending on the contaminant, the wash temperature maximum of 40°C (105°F) might not be the most effective temperature for cleaning those ensemble elements that can be subjected to higher wash temperatures in washer/extractors. However, even with this recognition, the technical committee was reluctant to increase the maximum wash temperature for advanced cleaning because it will occur more frequently than specialized cleaning or disinfection or sanitization and, to date, only limited testing has been done on the effects of multiple washings at 60°C (140°F) on garment ensembles and ensemble elements. Based on this work, there is a tradeoff between increasing the wash temperature for purposes of contaminant removal and the impact of the increased wash temperature for adversely affecting the performance properties of ensemble elements.

*Effects of Increasing Wash Temperature for Removal of Contaminants.* Fire fighter protective ensembles and ensemble elements might be contaminated with soot and chemicals such as polynuclear aromatic hydrocarbons (PAHs), phenols, phthalates, hydrocarbons, heavy metals, and other hazardous materials during fire responses, various chemical compounds from hazmat responses, and microorganisms during medical responses or biohazard responses. Appropriate removal of these contaminants is necessary both for protecting the health of the fire fighter and for ensuring that the gear performance is not compromised. To assess appropriate turnout cleaning parameters, specifically wash temperature, it is useful to consider the cleaning recommendations for garments used in agricultural and health care applications because such applications involve hazardous materials to which ensembles and ensemble elements might also be exposed: pesticides and infectious agents.

Extensive research has been performed to examine the effectiveness of different laundering procedures in removing pesticides. This information is relevant to fire fighter ensembles and ensemble elements because pesticide chemicals have a range of properties that are similar to fireground chemicals in terms of low volatility and often low water solubility. Research from several sources has shown that higher wash temperatures of up to 60°C (140°F) have greater efficacy at removing pesticide contamination, as reported in the following references:

(1) Thostenson, A., et al. “Laundering Pesticide-contaminated Work Clothes (PS1778).” North Dakota State University Extension Service, January 2016. [www.ag.ndsu.edu/publications/crops/laundrying-pesticide-contaminated-work-clothes/ps1778.pdf](http://www.ag.ndsu.edu/publications/crops/laundrying-pesticide-contaminated-work-clothes/ps1778.pdf).